

Cosentino® Bathroom Collection



SILESTONE®

—

DEKTON®

—

SENSA

PRODUCT
CONTENT

Cosentino® Bathroom Collection

SILESTONE®

—

DEKTON®

—

SENSA

COSENTINO®

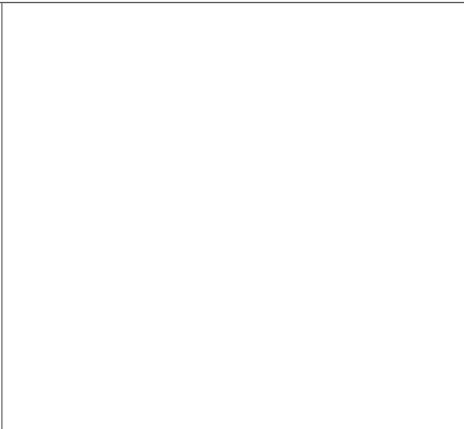

→ 06

01 COSENTINO®

Corporate Purpose	→ 06
Certifications	→ 08

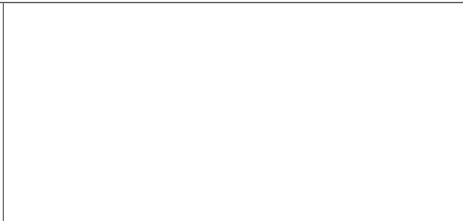
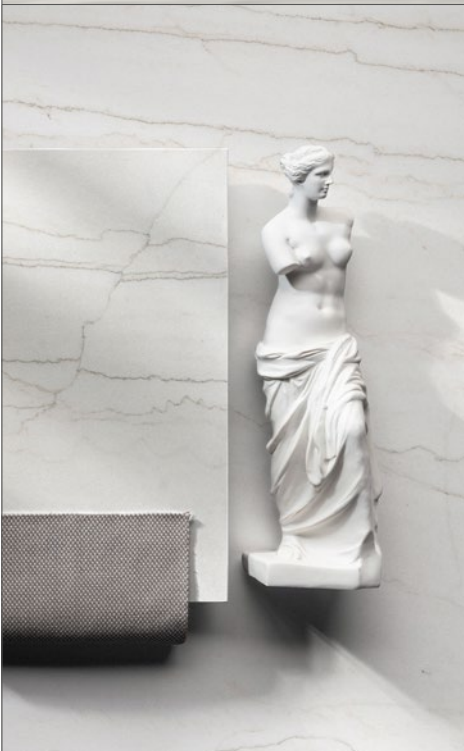

→ 10

02 SUSTAINABILITY

Energy	→ 11
Water	→ 12
Materials	→ 12
CO ₂ Neutral	→ 13



→ 14

03 COSENTINO® BATHROOM

Introduction	→ 14
Applications	→ 20



→ 22

04 PRODUCTS AND BRANDS



Dekton®	→ 22
Dekton® Slim	→ 25
Dekton® Colours	→ 34
Silestone®	→ 38
Silestone® Colours	→ 48
Sensa by Cosentino®	→ 52
Sensa Colours	→ 54



→ 56

05

BATHROOM COLLECTION

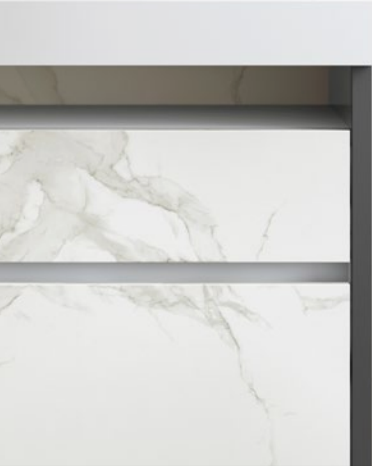

→ 56

5.1

WASHBASINS



Custom Design Operations

→ 79

→ 80

5.2

SHOWER TRAYS



Custom Design Operations

→ 92

→ 94

5.3

BE INSPIRED



→ 116

5.4

ACCESSORIES



→ 118

5.5

WARRANTY

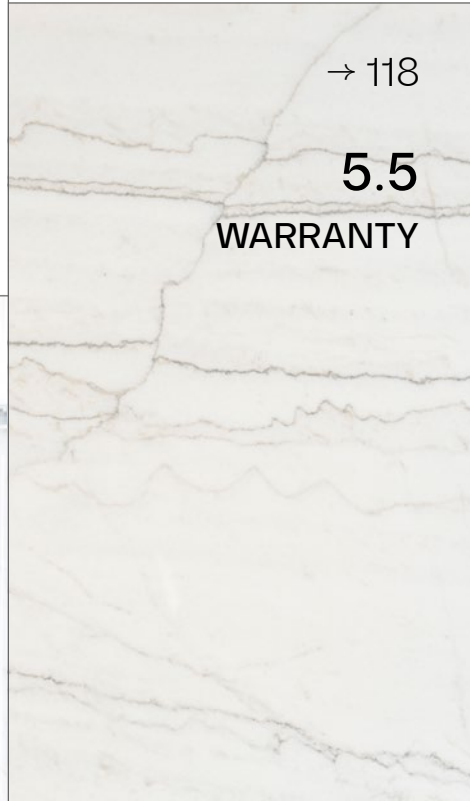

Table of Contents



Corporate purpose

To inspire people
through innovative
and sustainable
spaces.

Cosentino® DNA

Approved safety, sustainability
and quality

Certifications

At Cosentino® we have a strong commitment to meeting the needs of our customers and suppliers and to the environment as the main character through the responsible management of our resources. To this end, we are committed to innovation and continuous improvement of our processes, products and services at a global level.

Cosentino®

- ISO 9001
- ISO 14001
- ISO 20400
- ISO 50001
- UNE 15896
- Leed and Breeam credits for Silestone®, Dekton® and Sensa by Cosentino®
- CSR (verified by KPMG) based on GRI (Global Reporting Initiative)

Silestone®

- Declare Label
- EPD (Envirodec)
- VOC (UL) Greenguard and Gold
- VOC (Eurofins) A+

Dekton®

- Declare Label
- DGNB Label
- EPD (Envirodec)
- VOC (UL) Greenguard and Gold
- VOC (Eurofins) A+
- Chemical Spot Test (SEFA)
- Fire Safety Certification APF-1525 (Applus), in accordance with EN 13501-1
- Combustibility Test (CSIRO), in accordance with AS 1530.1
- Fire Euroclass A1 (Tecnalia), in accordance with 13501-1
- Burning Characteristics (QAI), in accordance with ASTM E84-15b
- IMO Module B 50171/A2 MED, in accordance with the Marine Equipment Directive 2014/90/EU - Ships.
- IMO Module D SMS. MED2.D/109819/A.0, in accordance with the Marine Equipment Directive 2014/90/EU - Ships.
- USCG Module B 164.117 / EC2690 - Boats. Fire Test NFPA 285 (Tecnalia)

Bathroom

Washbasins

- DoC (Declaration of Conformity), in accordance with EN 14688
- CSA 800580/IAPMO TJ5065 (QAI), in accordance with CSA B45.5-17 / IAPMO Z124

Shower trays

- DoC (Declaration of Performance), in accordance with EN 14527
- Slip-Resistant DIN 51097
- CSA 800580/IAPMO TJ5065 (QAI), in accordance with CSA B45.5-17 / IAPMO Z124



⁽¹⁾ Check each approved model.



Cosentino® Sustainability

At Cosentino® we approach sustainability as a collective commitment that stems from the individual involvement of those that are part of Cosentino®.

Our continuous improvement efforts involves a constant analysis of our entire value chain – from the procurement of raw materials to the delivery of end products to customer.

At Cosentino® we are strongly committed to the 2030 Agenda promoted by the United Nations. The company, in view of its position as a global leader in the production and distribution of innovative surfaces for decoration and architecture from its Almería base, is committed to driving the local and global sustainability efforts.

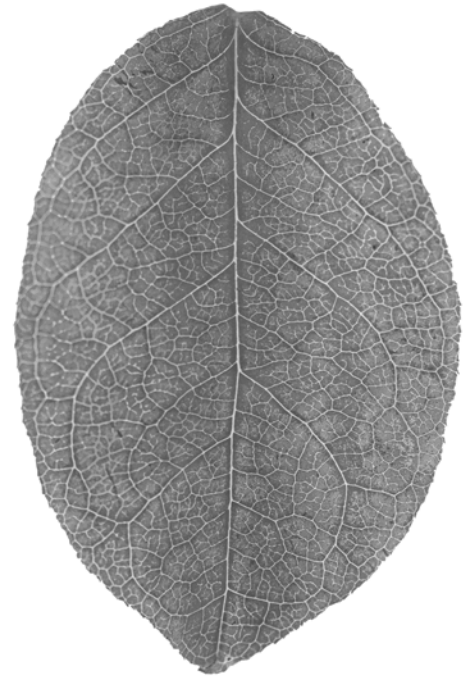

→ Olive trees in the Cosentino®'s industrial park



→ LED lighting in the Cosentino®'s industrial park



→ Photovoltaic installations at Cosentino®

Energy

Energy efficiency and the use of renewable energy sources are the two key elements of our strategy to minimise the impact of our activities.

First of all, 100% of our energy consumption comes from renewable energy sources. Furthermore, by 2023 we aim to achieve 15% self-consumption of energy.

On the other hand, the constant improvement of our processes and machinery allows us to achieve a high level of energy efficiency, which translates into an 8% reduction of our electricity consumption in our production processes.

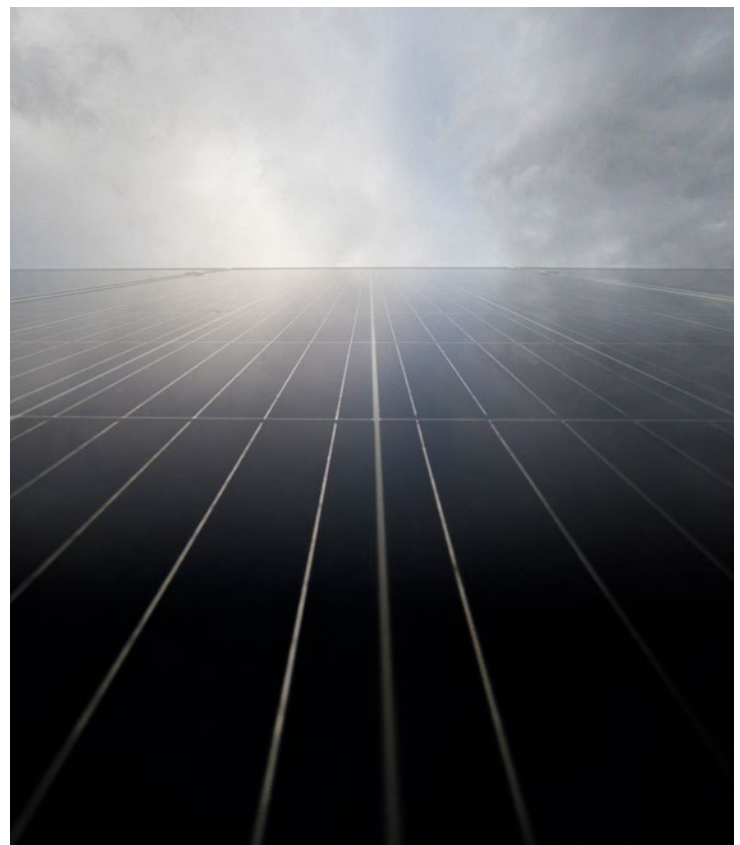

Water

Since our inception, we have appreciated the importance and understood the challenges of proper water management.

This has motivated us to implement a sustainable use policy maximising the efficient use of water resources in the different production processes.

We use cutting-edge technology to achieve 99% recycled water in all our production processes in the Cosentino®'s industrial park.

Additionally, we use 100% of surplus water to irrigate green areas.

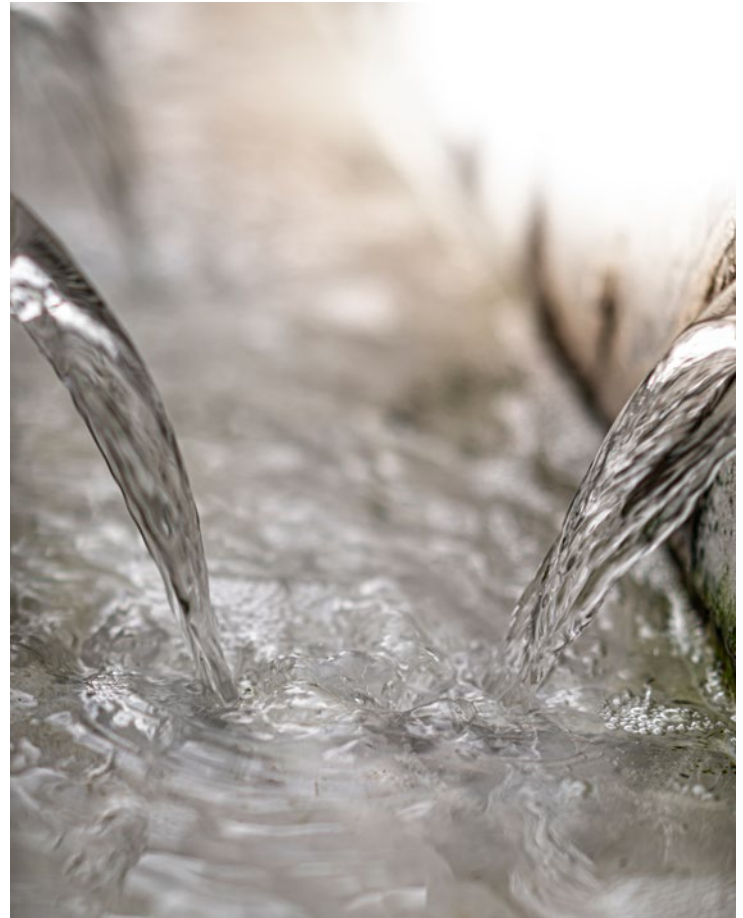

Materials

We are aware of the importance of making the most of the materials we work with, both from the beginning of their life cycle to the end of the value chain.

With this goal in mind, in recent years we have embarked on an ambitious R&D project called 'Circularity' to reuse the materials from which we manufacture our products.

Another action is the disruptive HybriQ+® technology that brings about the new generation of Silestone®. HybriQ+® contains a minimum of 20% recycled materials and is manufactured using only renewable energy and 99% recycled water.

Carbon neutrality: Sustainable Development



Cosentino® Group considers sustainable development as an essential commitment in the company's growth strategy, with regard to the respect and protection of the environment.

We address aspects related to the efficient use of natural resources, proper waste management, atmospheric emissions, discharges and other potential impacts in order to make sustainable use of natural resources and protect biodiversity and ecosystems.

At Cosentino® we are strongly committed to the 2030 Agenda promoted by the United Nations and the Local Action Plan promoted by the Spanish Government.

As a demonstration of our commitment, we have managed to offset the 42,532 tonnes of CO₂ emissions resulting from one year of Dekton® production, thus obtaining the Zero Carbon Footprint label for the entire product life cycle in 2019 for all Dekton® brand products.

In addition, the Sunlit Days series by Silestone® is the brand's first collection to achieve this certification.



We reduce our impact

We are committed to energy efficiency, emissions reduction and sustainable mobility to minimise our impact.

- **Energy efficiency:** it is a priority objective for Cosentino® to reduce energy consumption in the production process and in the general Group activity, which is why we have managed to obtain 100% of the electricity we use from renewable sources.
- **Emission reduction:** 2.8 million euros have been invested in the implementation of an energy management and monitoring system for the heat systems, which allows heat from the Dekton® kilns to be recovered and used in the dryers, thus reducing emissions.
- **Sustainable mobility:** we have recently joined the 'Plan Sumamos Salud + Economía' under which we have a Mobility Policy that helped us to avoid the emission of 230 TCO₂ in 2018.



We calculate our carbon footprint

It is an external body that verifies the calculation and the results of the carbon footprint that are submitted to the Spanish Ministry for Ecological Transition and Demographic Challenge (MITECO, in Spanish), which is responsible for approving and registering our Footprint, becoming part of the 'Spanish registry of carbon footprint, offsetting and carbon dioxide absorption projects' of the Spanish Climate Change Office (OECC, in Spanish), whose results are made public as an exercise in transparency.

This calculation uses energy and/or fuel consumption data, as well as raw material consumption data collected from all **Group subsidiaries** (Centres, Workshops, Cities, HUBs, HQ, etc.) with a view to offset these emissions.



We offset our emissions

To achieve carbon neutrality in Dekton®, at Cosentino® **we offset our emissions over the entire product life cycle** (scopes 1+2+3) by investing in GHG emission reduction projects.

For this purpose, we identify those projects that meet the requirements for responsible offsetting and that, in turn, have a strong social dimension that contribute to the achievement of the **Sustainable Development Goals of the UN's 2030 Agenda**.

The project selected to offset the 42,532 tonnes of CO₂ emissions, resulting from one year of Dekton® production, has a direct impact on sustainable development by **supporting the local economy, providing training and job opportunities**.

Reimagine your space

Home spas

Cosentino® Bathroom

The latest
technology for
sustainable
and design
bathrooms.

At Cosentino® we have developed a wide collection of surfaces and bathroom elements, such as washbasins and shower trays, in different finishes, textures, formats and featuring the latest innovation to bring any project to life.





Innovation and design for the bathroom.

Create a unique experience in which the most beautiful and functional Cosentino® surfaces transform warm and exclusive spaces.

From wall and floor claddings in different yet perfectly balanced formats, colours and textures, to attractive washbasins and shower trays, carefully designed with great attention to detail and simplicity.

Solutions of great aesthetic and functional value to suit every requirement and style of bathroom, which redefine the way in which we experience such a personal space and feeling of well-being.



XXL format

Large format and minimal joints.

Bathrooms are exposed to constant activity. Using a high quality surface for flooring and cladding reduces joints and ensures hygiene and cleanliness. In addition, the strategically placed XXL slabs make the room larger, creating the feeling of a larger bathroom.

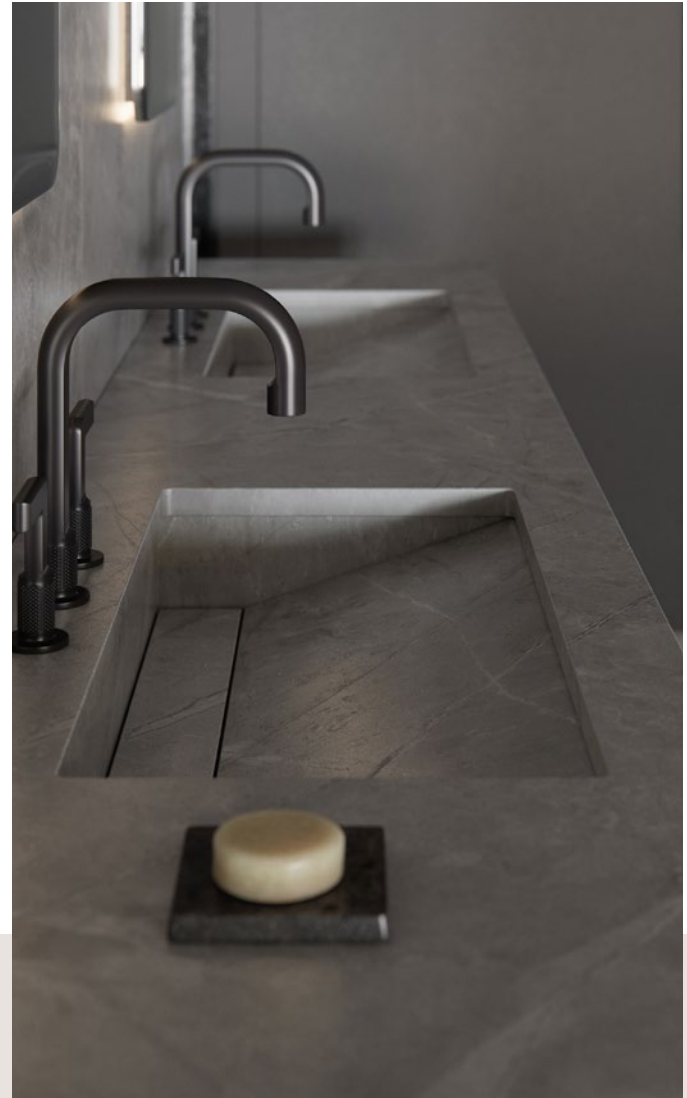

Architect: Pedro Francisco
Interior design: Alexia Martínez

Shower trays

Shower trays with Dekton® Grip+ and Silestone®: exclusive and integrated bathroom designs with endless customisation possibilities.

Cosentino® offers an extensive collection of shower trays in the material of choice for the architect or designer, adaptable to any space. This is an interesting alternative to the traditional shower that simplifies installation and assembly.

Washbasins

And countertops with great versatility that suit any space. Sophisticated designs with maximum beauty and durability.

Silestone® washbasins are built with a unique and innovative design capable of living up to the most demanding creative projects. From washbasins integrated into the countertop to countertop washbasins, double basins, etc., everything is possible with a custom manufacture.

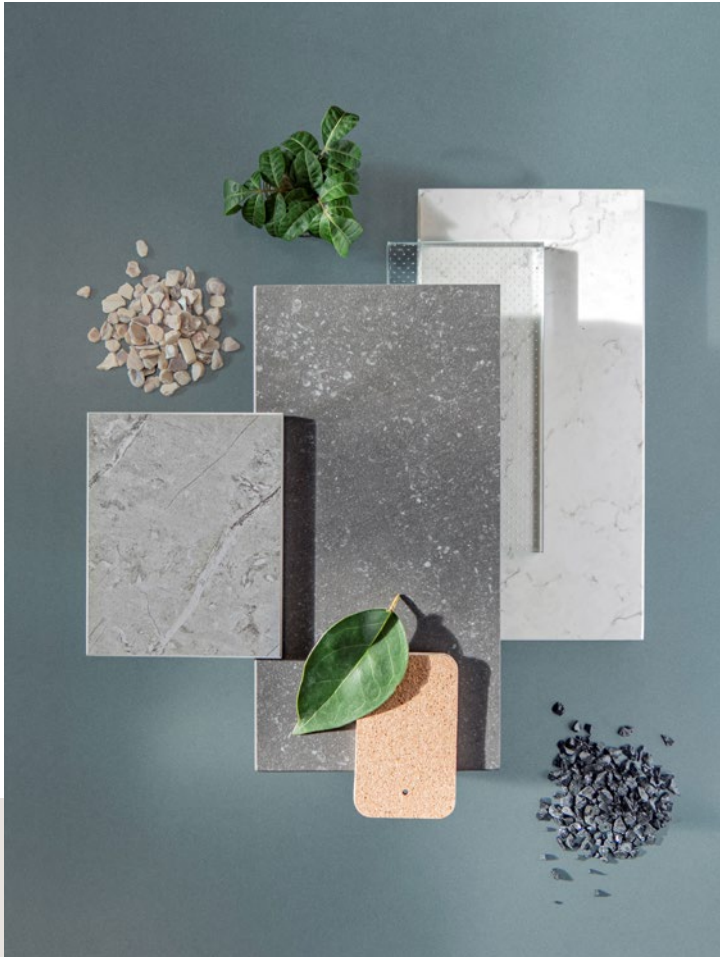

Colours and textures

New collections of innovative, on trend colours and textures, to create bathroom spaces full of originality and impact.

The Silestone® and Dekton® surfaces offer a wide variety of solid and veined colours, unique chromatic patterns and sensory textures to rediscover bathroom spaces.

Optimma format

Optimised for interior bathroom cladding: maximum use of the slab, easy installation and continuous design in a vertical format.

Optimma is the slab format measuring 2,600 x 1,000 x 4 mm from the Dekton® brand, which can be applied to any vertical cladding and create a continuous design, taking advantage of its full height, easy installation and minimum waste.



Custom design

All our products are manufactured to order. Some of them are available in the recommended standard formats, but they can be made to measure to suit the space and needs of each customer.



Total Integration

Visual and aesthetic continuity.
The same surface for all of your bathroom: floor, cladding, shower tray and washbasin.

The use of a single surface for all bathroom components allows for complete aesthetic homogeneity, thus achieving harmony, balance and spaciousness.

Applications for bathrooms

Thanks to their low porosity and high resistance to stains and scratches, Cosentino® surfaces and manufactured products allow any design to be freely created, guaranteeing maximum durability.

The variety of formats and thicknesses of Silestone®, Dekton® and Sensa by Cosentino® surfaces optimises their assembly in any project, facilitating their aesthetic integration with washbasins and shower trays in the same finishes.



Wall cladding
Silestone® | Dekton®



Bathroom countertop
Silestone® | Dekton®



Flooring
Silestone® | Dekton®



Washbasins
Silestone® | Dekton®



Furniture cladding
Dekton®



Showers | Shower trays
Silestone® | Dekton®



Innovation in design

Dekton® is a sophisticated blend of more than 20 minerals extracted from nature. Its production process is the result of years of learning and inspiration in the manufacture of glass, cutting-edge porcelain tiles and quartz surfaces.

As a result of an exclusive sintering and ultra-compaction process, Dekton® presents a low porosity, which generates a surface with no micro-defects that cause tensions or weak points.



Sinterized Particle Technology

Dekton® uses in its manufacturing the exclusive TSP technology, capable of sintering mineral particles, causing them to bond, change and compact their internal structure. A unique and innovative technological process that represents an accelerated version of the metamorphic change that natural stone undergoes when subjected to high temperatures and pressure over thousands of years.

In the span of a few hours, Dekton® emulates what nature takes thousands of years to create, thanks to the exclusive TSP technology.

- The kiln is 180 metres long.
- Temperature reaches approximately 1250°C.
- The total time of the process depends on the thickness of the slab (about 4 hours).

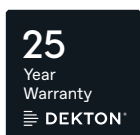

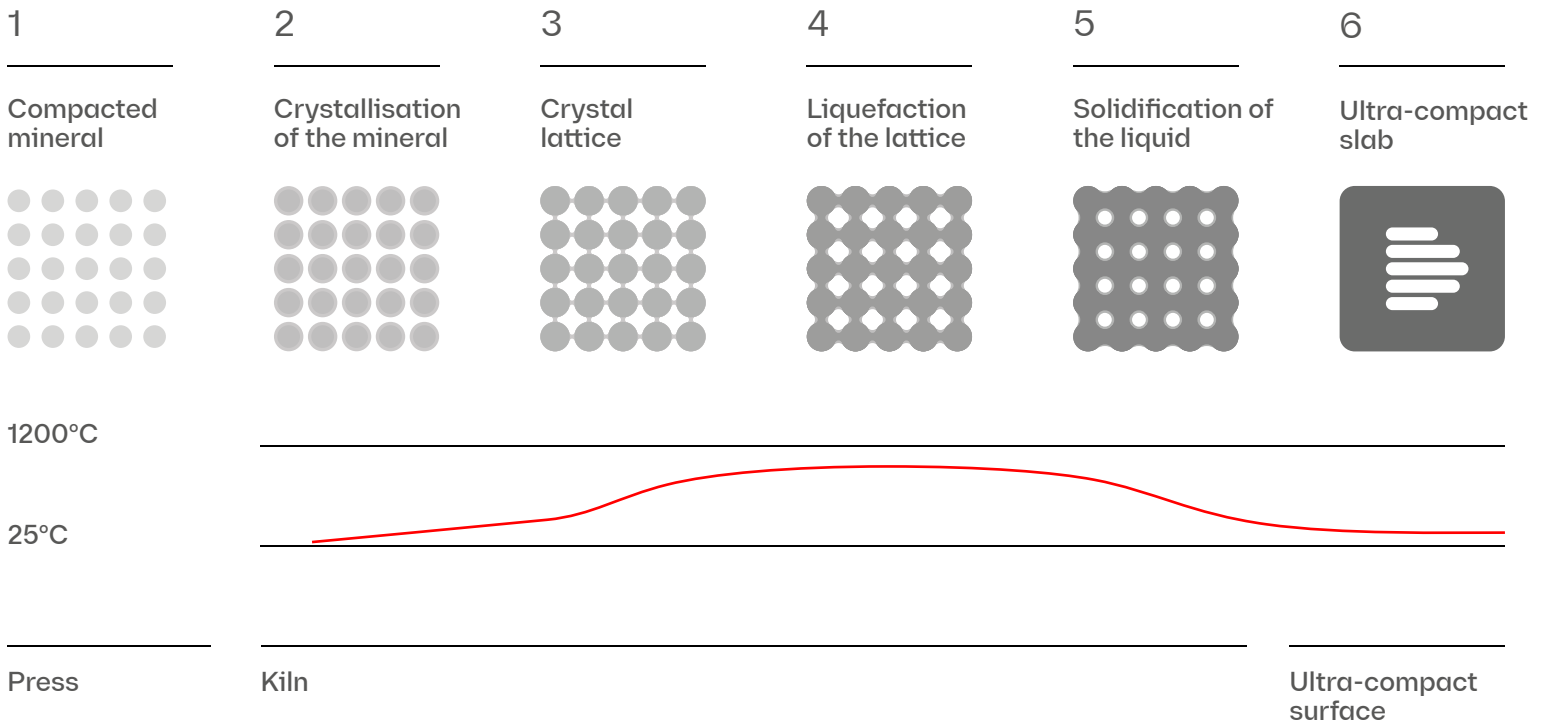

Dekton®^R, high performance design

Dekton® Product features

Dekton® has all the technical features demanded of a highly resistant surface suitable for all types of interior and exterior residential design projects.



Low water absorption

Dekton®'s water absorption is negligible, and therefore is not affected by this type of movement of expansion.



Highly resistant to UV light

Dekton® is highly resistant to UV light and will not fade or degrade over time in any kind of outdoor application.



Superior mechanical resistance

Dekton®'s variety of thicknesses allow it to be used in applications where resistance to wind or impact are a project requirement.



Fireproof material

Dekton® can withstand high temperatures without burning, scorching or cracking. European Standard EN 13501 and ASTM E84 testing classifies ultra-compact surfaces as non-combustible.



Colour durability

Dekton®'s control of pigmentation and decoration in the manufacturing process provides better colour consistency from one slab to another, resulting in a long lasting product that will not fade over time.



Scratch resistant

Dekton® is one of the most scratch-resistant surfaces on the market. It has achieved a score of seven (7/10) on the Mohs scale of mineral hardness.



Dimensional stability

Dekton® expansion is minimal so it can be installed with thin joints between panels. These joints will keep their width in all conditions.



Resistance to freezing and thawing

Dekton® resistance to durability tests in freezing and thawing situations and its application in various weather conditions prove its high performance.



Abrasion resistant

Dekton® is even more resistant to abrasion than granite and porcelain, making it the ideal surface for façades or high-traffic flooring in commercial applications.



Maximum fire and heat resistance

Dekton® has been successfully installed on façades in areas exposed to high temperatures.



Easy cleaning and low maintenance

Most graffiti can be removed from Dekton® with standard cleaning products. As a result, maintenance costs are reduced.



Stain resistant

Dekton® is resistant to stains from a variety of sources so they will not be permanent.

DEKTON® SLIM

Designed by COSENTINO

High aesthetic value and performance in vertical cladding and furnishings.

Minimum thickness of 4 mm → Large format and performance

Dekton® Slim is the new, large format surface with an ultra-thin 4 mm thickness that offers unlimited design options and incredible ease of installation and transport. Ideal for bathroom and kitchen floors and walls, as well as all types of furniture.

01 → Large format and minimum number of joints

Its large format measuring 3,200 mm x 1,440 mm covers large surfaces, avoiding a large number of joints and in turn, dirt.

02 → Easy installation

Thanks to its light format with an array of possibilities, everything just got a lot simpler. Its reduced thickness means that it can be cut quickly and adjustments can be made on site with tools for ceramic tiles.

03 → Limitless design

Dekton® Slim is easy to assemble and can be cut to size. It can be adapted to all spaces.

04 → Highly resistant to moisture

Ideal for bathrooms, Dekton® Slim offers cladding that is ultra-resistant to moisture and stains. A high-performance product that does not require any maintenance other than a damp cloth.

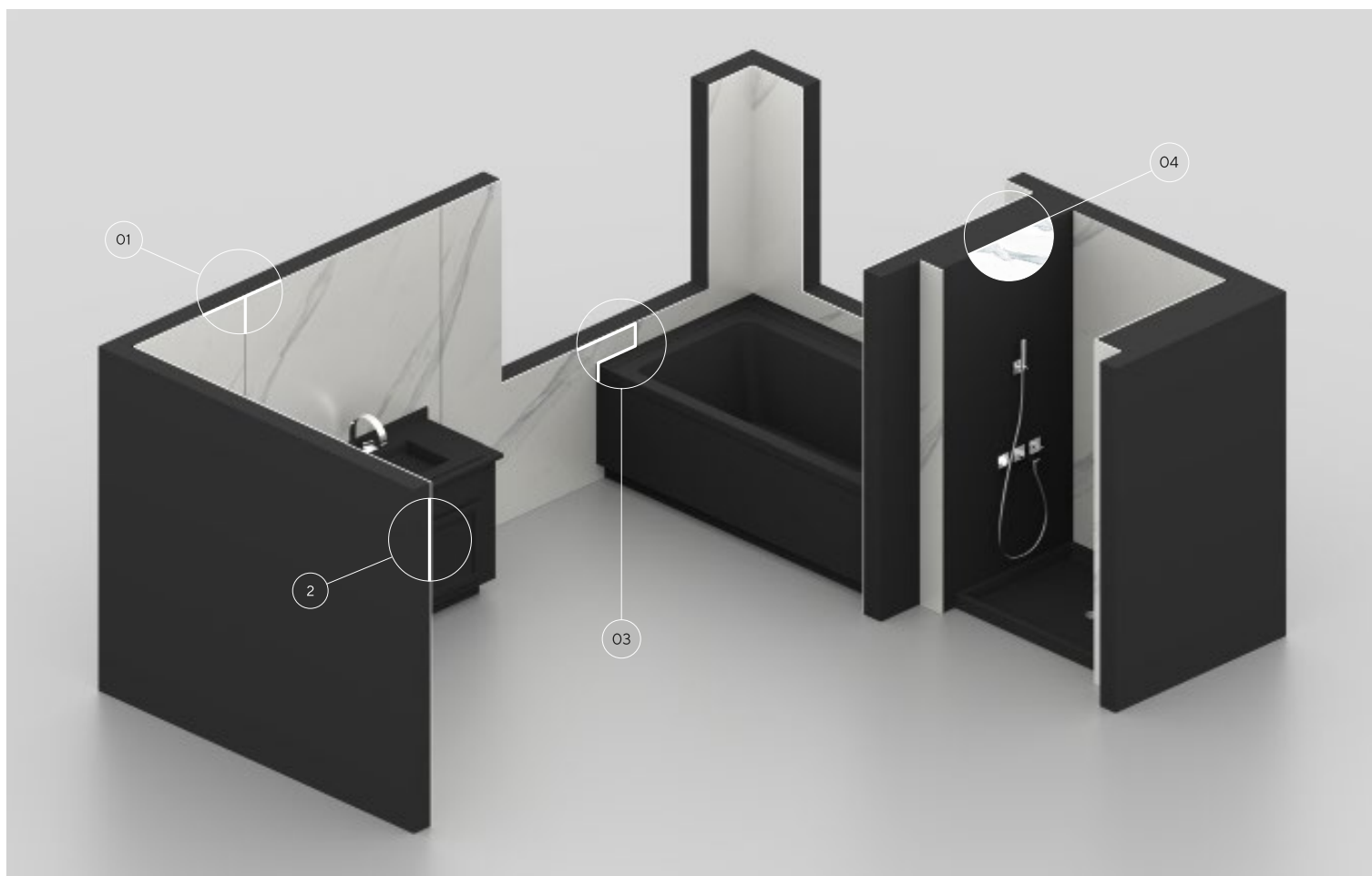

Dekton® formats

Adaptable and versatile.
For any space.

Thanks to its light format with an array of possibilities, everything just got a lot simpler. Its reduced thickness means that it can be cut quickly and adjustments can be made on site with tools for ceramic tiles.



Large format

Optimma format → 2,600 x 1,000 mm
Large format slab → 3,200 x 1,440 mm

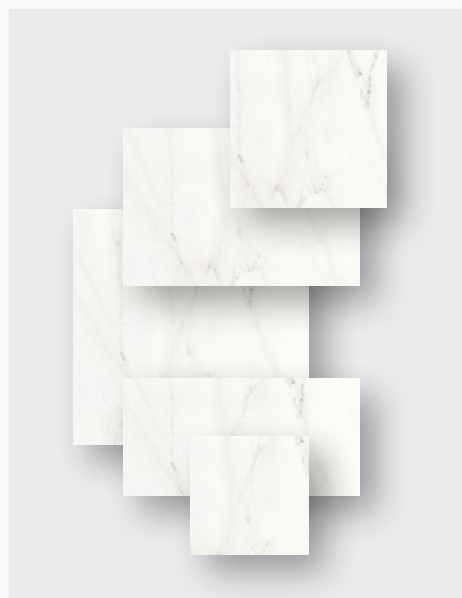

Cladding format

- 1,060 x 710 mm
- 1,420 x 1,060 mm
- 1,420 x 1,420 mm
- 1,420 x 710 mm
- 1,420 x 790 mm
- 1,590 x 1,420 mm
- 1,590 x 710 mm
- 710 x 710 mm
- Custom formats
- Optimma format



Thicknesses

- 4 mm
- 8 mm
- 12 mm
- 20 mm
- 30 mm

Dekton® textures

Different material sensations.
A rich variety of shades.

Dekton® comes in different textures so that the only limit is the imagination of the architect or designer: from an ultra glossy finish, to matt or velvety textured finishes.

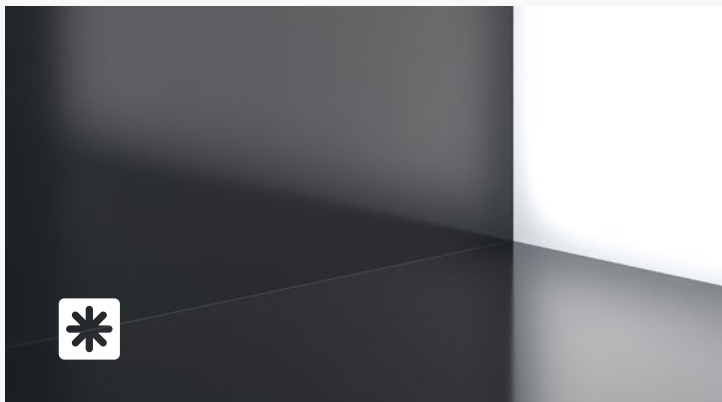

X-Gloss

A bright, dazzling finish achieved through mechanical polishing, without the need for glazes or other materials.

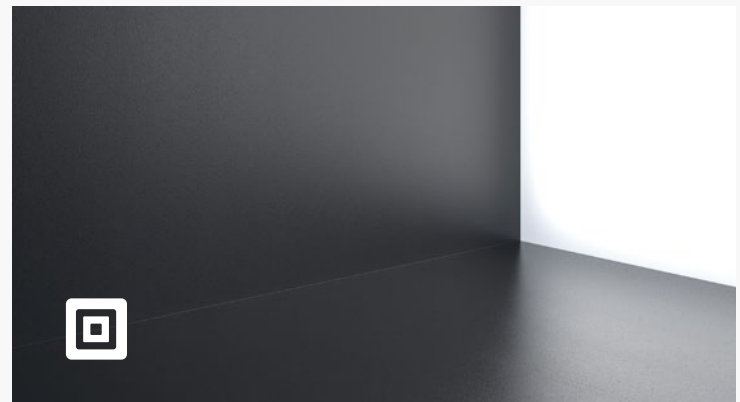

Matt

The matt texture aims for a natural, shine-free look, ideal for a harmonious and timeless finish. Most Dekton® products come in this finish.

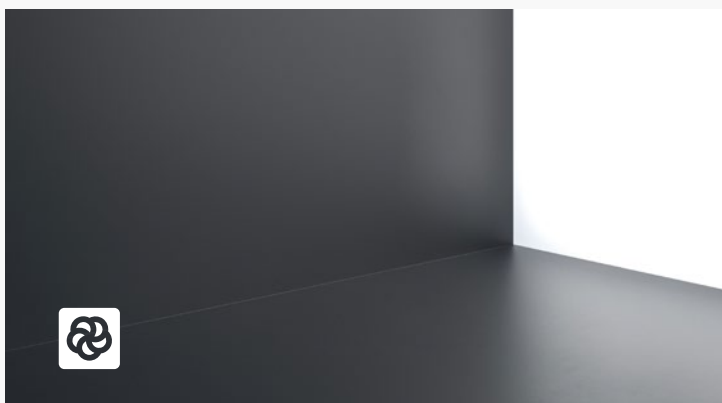

Velvet

Velvet is Dekton®'s velvety texture. The materials chosen in Velvet create a feeling of warmth and comfort. This texture is perfect for classic colours, with veins.

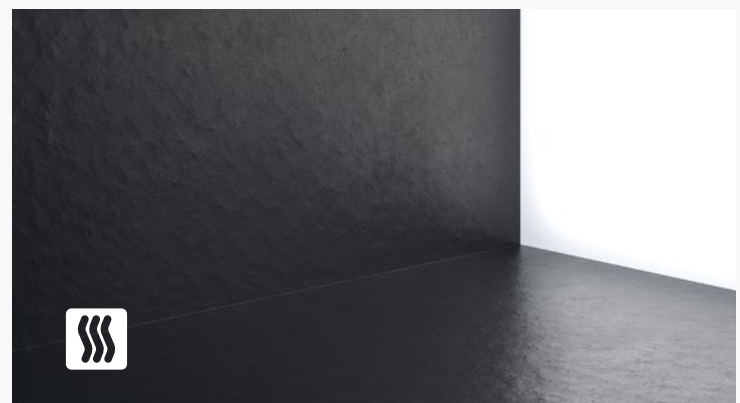

Matt and Textured Velvet

Matt and Textured Velvet textures combine the warmth of velvet with the roughness of a textured, imperfect material. It is perfect for emulating the finish of natural stone.

Optimma

New optimised
Dekton® format.

The ultimate interior
cladding solution.

The Dekton® slab has been optimised taking into account its common applications to create a new format with better price, design, installation and handling. Here we present our first format of the Optimma family specifically designed for cladding: Optimma format 2,600 x 1,000 x 4 mm.

Optima Collection

The Optimma format is available in the following colours: Bergen, Laurent, Aeris, Rem, Kreta, Kelya, Nacre and Zenith.

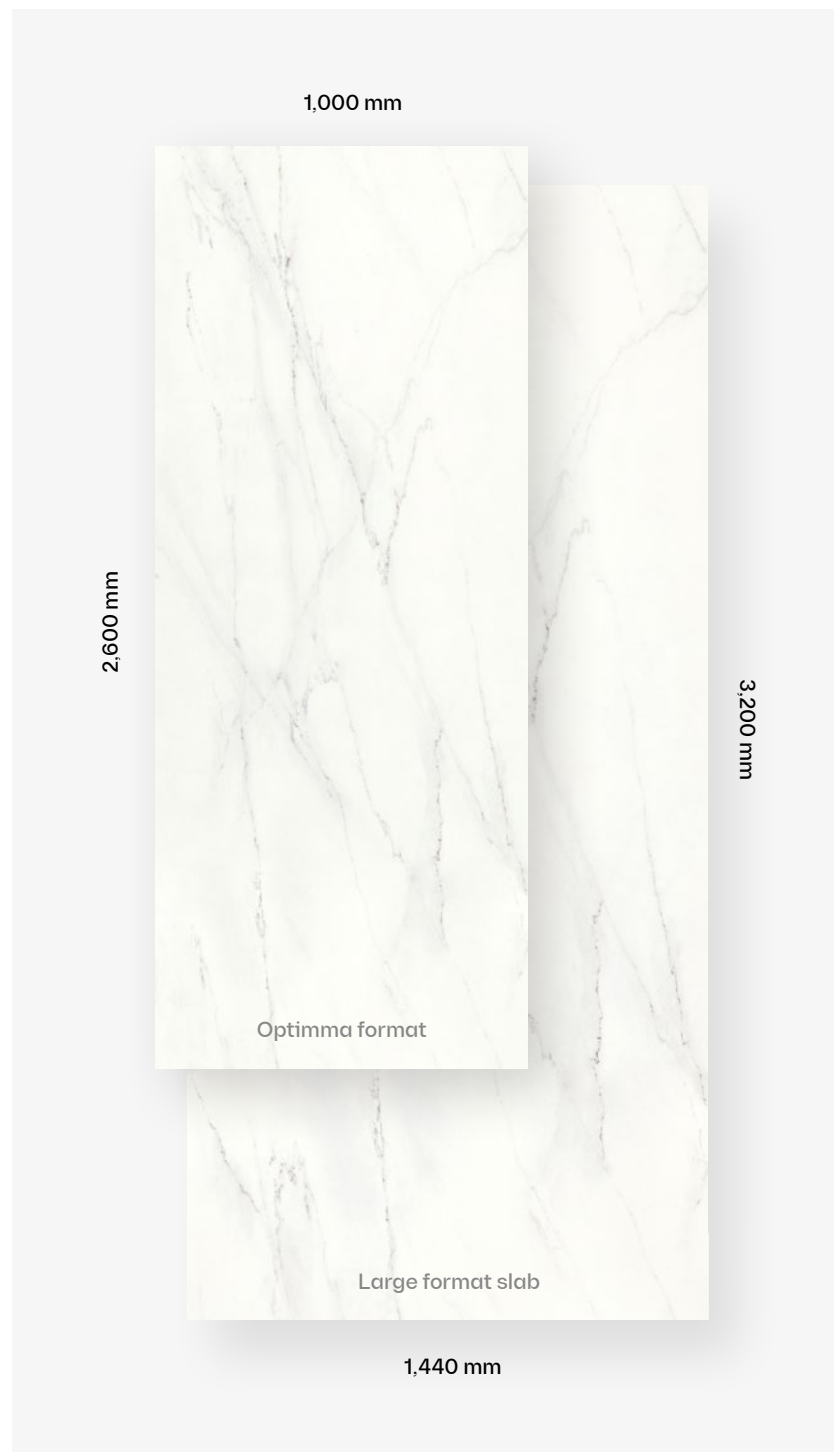

**2,600 x 1,000 mm
in 4 mm thickness**

The slabs are created in 4 mm thickness, which gives it a lightness that allows for easy handling and, if necessary, it can be easily cut to adapt the product to all spaces.



Cost-effective

The dimensions have been optimised to the most common cladding standards, which allow us to reduce excess material and economise on the price of the piece.



Design with purpose

The slab has been created to maximise its overall height, making it much easier to cut for cladding.



Easy to install

The product is smaller and lighter, which makes it easier to transport and handle. Cutting can be done with simple tools. The piece is always delivered in mesh and with edges already bevelled.



Match design

The design has been conceived to place the slabs vertically, thus creating a continuous design.



The beauty of handcraft

Kraftizen Collection

Our challenge has been to reinterpret craftsmanship with digital craft technology. Both technique and technology are complementary and feed back, refine and inspire each other.

The walls and trowel marks of yesteryear are transformed into canvases of millions of pixels, where tools and hands continue to shape beauty. Each trowel stroke, each twist of the wrist becomes part of an image, of a reinterpretation with no expiry date.

We have created a refined technique through technology shaping a durable surface that delights the five senses through textures and volumes, silky and extra matt colours that will clad floors, walls, tables, worktops and any timeless space.

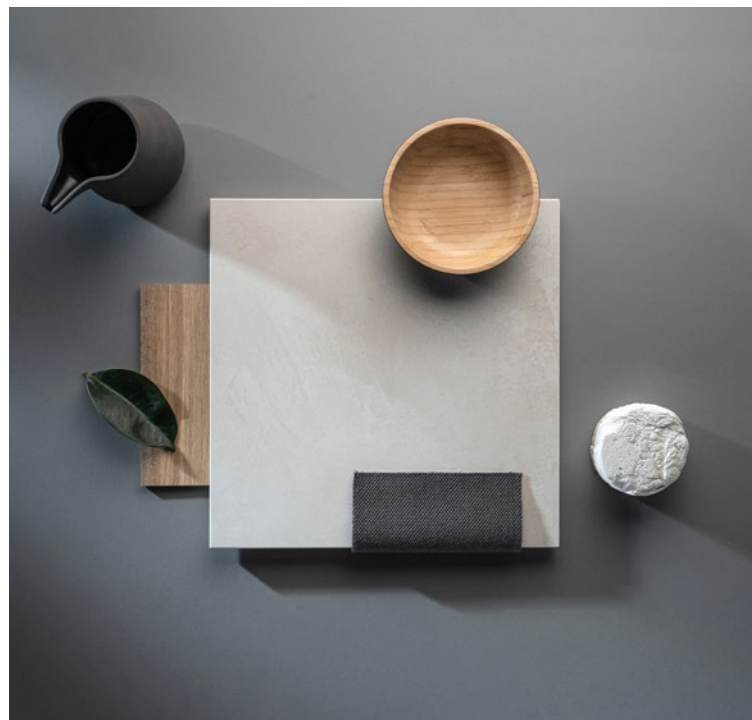

Albarium 22

Argentium

Nacre

Umber

Micron



Dekton® Nacre

Beauty is immersive hi-tech design

Onirika Collection

Onirika represents a journey. A detour in our dreams where boundaries between dreams and reality vanish.

'A collection that unites the poetic and unique beauty of stones harnessed by Dekton® technology, like those dreams where we observe and vaguely feel in control but only the deepest part of our mind truly understands.'

The collection is named after the lavish inspiration of two worlds conveyed in marble-inspired colours to captivate our eyes and to infuse any space with a feeling we understand but cannot explain in words.

Designed by
Nina Magon

'Imagine sitting in a world of beauty, that blurs the division between reality and dreams.'



Nina Magon Studio, formerly Contour Interior Design, is a luxury design studio where architecture, interior design and construction blend seamlessly to deliver the world's most exclusive residential, hotel and spa projects.

The firm's innovative spirit is combined with exceptional service, ideas and personalised experiences for all its customers, based on the premise that luxury is not only elemental, but also part of its essence. At Nina Magon Studio they adhere to uncompromising standards and create exquisitely luxurious spaces through experimental and one-of-a-kind designs, which they tailor to the needs and desires of their customers and their imagination.

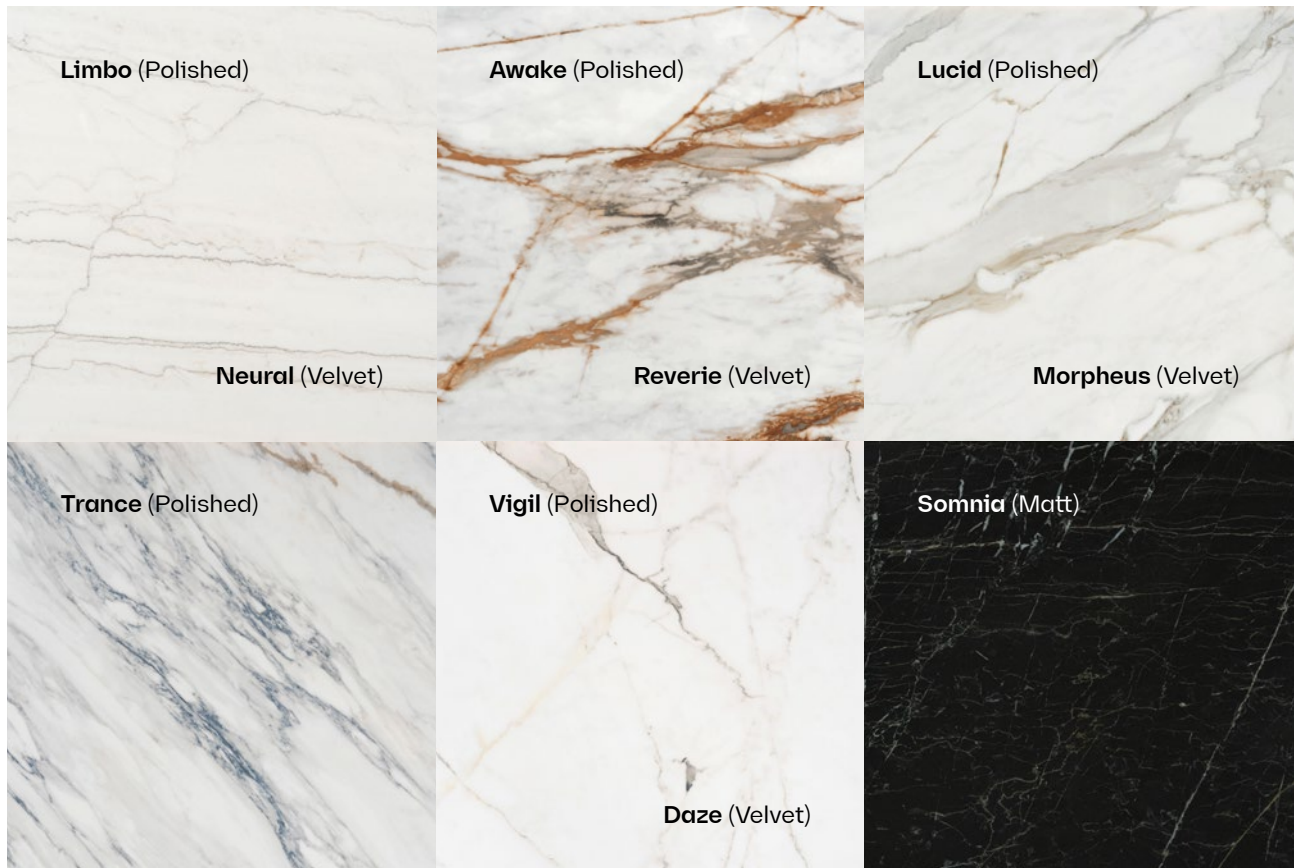

Dekton® Somnia (Matt)

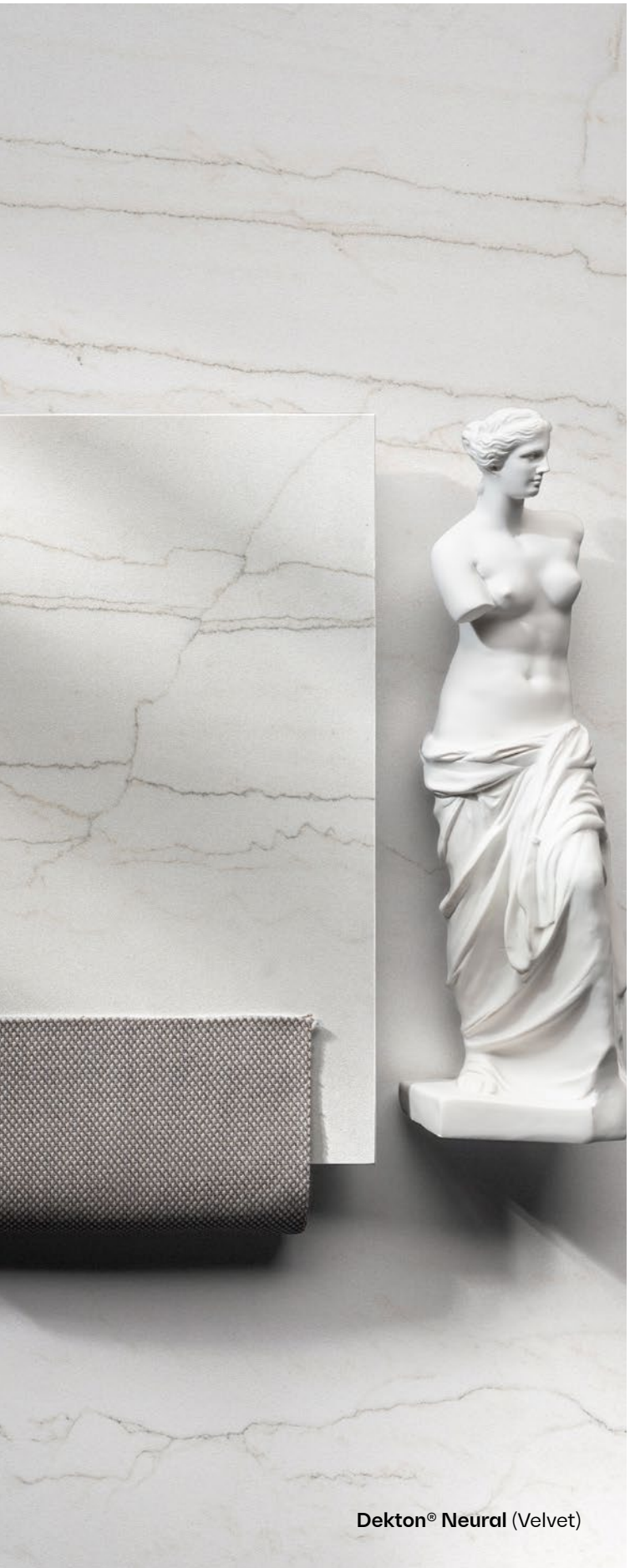

Dekton® Neural (Velvet)

Dekton® Collection

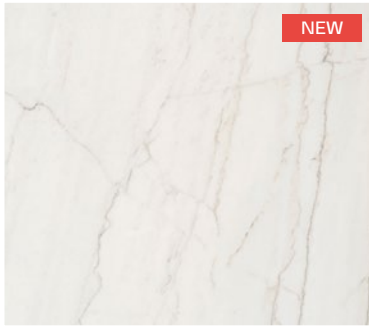

Neural ONIRIKA ☼

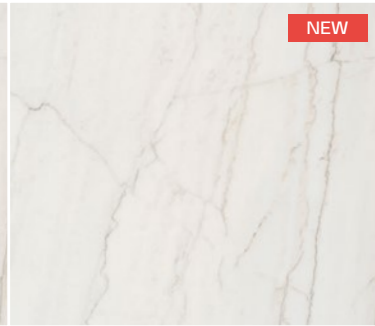

Limbo ONIRIKA ☼



Vigil ONIRIKA ☼



Daze ONIRIKA ☼

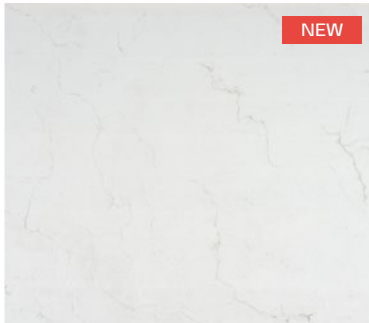

Malibu SilverKoast ☼



Laguna SilverKoast ☼



Salina SilverKoast ☼



Marina SilverKoast ☼

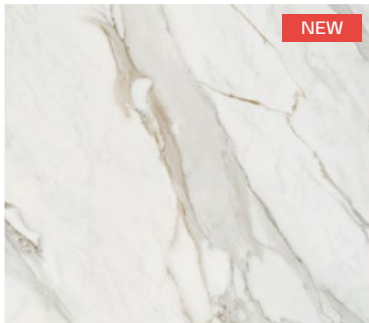

Lucid ONIRIKA ☼



Morpheus ONIRIKA ☼



Awake ONIRIKA ☼



Reverie ONIRIKA ☼

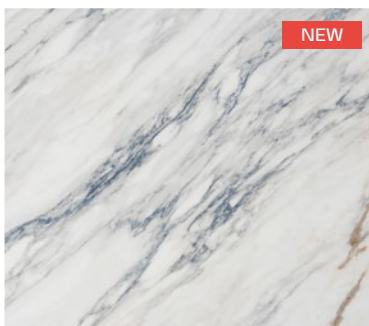

Trance ONIRIKA ☼

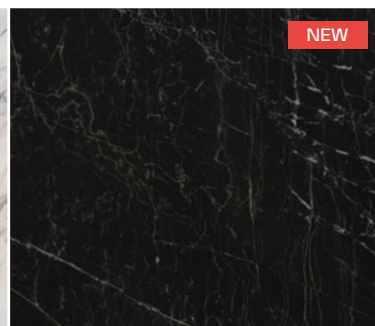

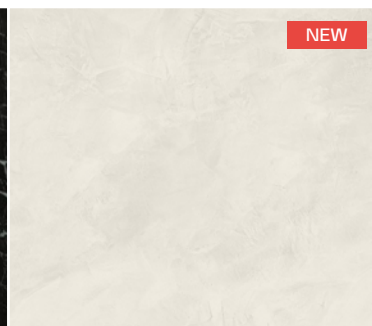

Somnia ONIRIKA ☼



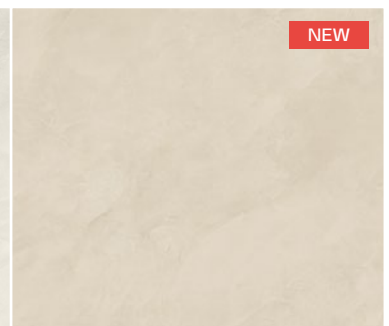

Albarium 22 Kraftizen Collection ☼



Nacre Kraftizen Collection ☼ H+*

-  POLISHED
-  MATT FINISH
-  TEXTURED FINISH

-  VELVET FINISH
-  DEKTON® GRIP+. Anti-slip solution for wet surfaces
-  DEKTON® SLIM 4 MM

* DEKTON® GRIP+. Approved exclusively for the Gocce shower tray

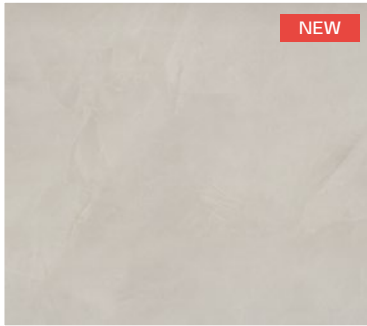

Argentium Kraftizen Collection 

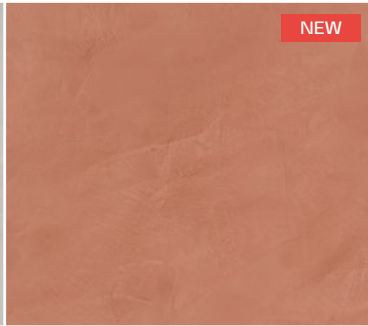

Umber Kraftizen Collection 

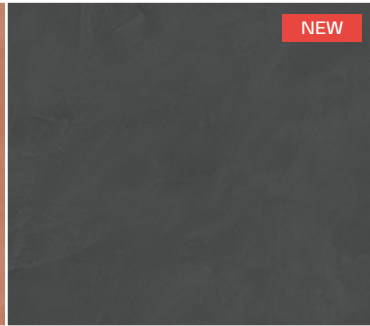



Micron Kraftizen Collection 

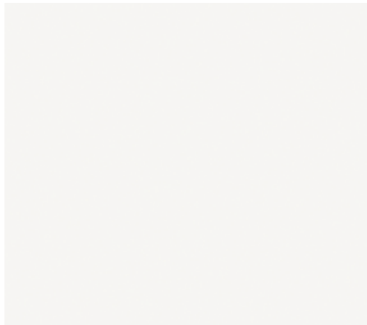

Uyuni Chromica  



Zenith SOLID Collection    *

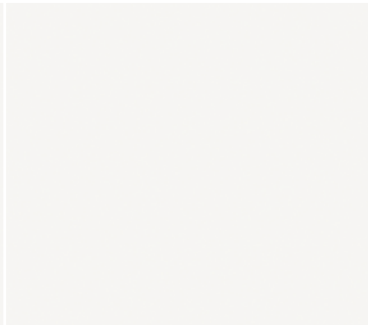

Halo XGLOSS Solid  

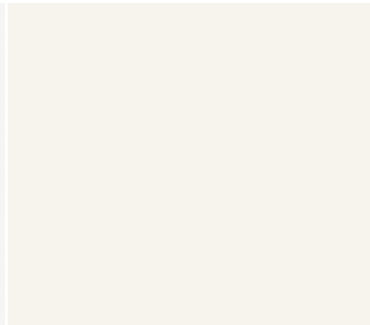

Mooné SOLID Collection 



Opera NATURAL Collection  



Entzo 22 NATURAL Collection 





Aura 22 NATURAL Collection   



Rem NATURAL Collection   *





Nilium 22 INDUSTRIAL Collection  

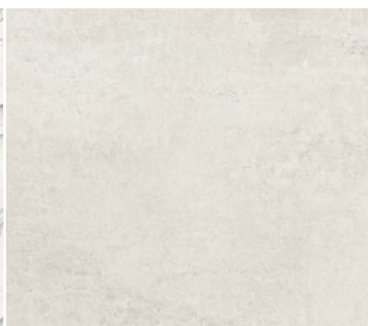

Sky LIQUID Collection 



Lunar 22 INDUSTRIAL Collection   



Natura 22 XGLOSS Natural  

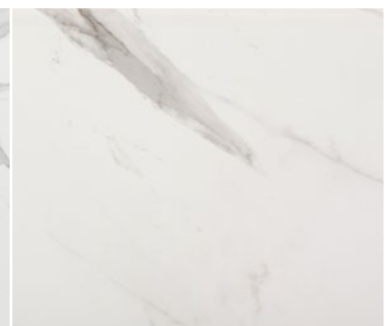

Olimpo STONIKA 

Dekton® Collection



Helena 22 STONIKA ✳



Bergen STONIKA ✳ 4



Portum NATURAL Collection 3



Aeris NATURAL Collection 4 4



Liquid Shell 22 LIQUID Collection 3



Danae NATURAL Collection 4 4

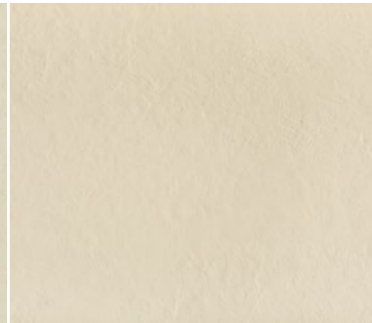

Edora NATURAL Collection 4 4



Sasea NATURAL Collection 4 4 4



Arga STONIKA ✳ 4



Taga STONIKA Collection ✳



Khalo STONIKA ✳



Valterra WILD Collection 4



Keon TECH Collection 4 4

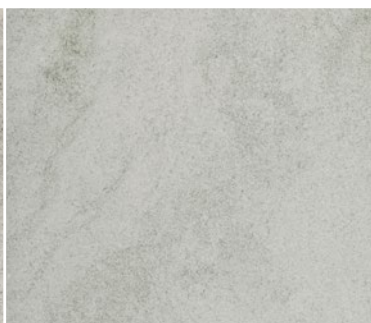



Kovik NATURAL Collection 4 4

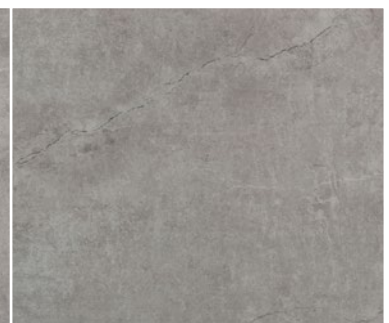

Kreta INDUSTRIAL Collection 4 4 4



Soke INDUSTRIAL Collection 4 4

-  POLISHED
-  MATT FINISH
-  TEXTURED FINISH

-  VELVET FINISH
-  DEKTON® GRIP+. Anti-slip solution for wet surfaces
-  DEKTON® SLIM 4 MM

* DEKTON® GRIP+. Approved exclusively for the Gocce shower tray



Laos INDUSTRIAL Collection   



Fossil NATURAL Collection 



Kira NATURAL Collection  



Trilium INDUSTRIAL Collection   

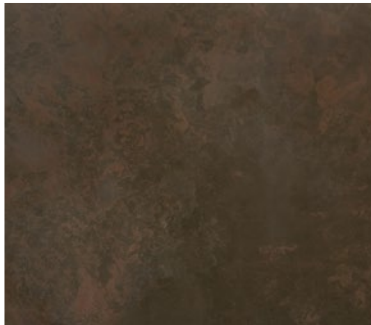

Keranium TECH Collection 

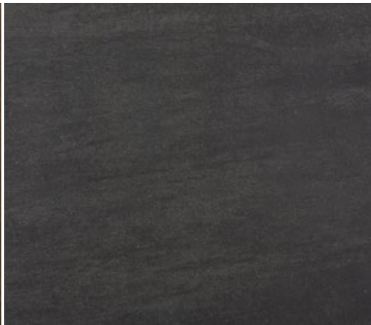

Bromo NATURAL Collection  

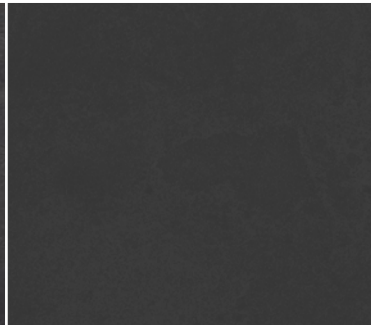

Eter NATURAL Collection  



Radium INDUSTRIAL Collection  

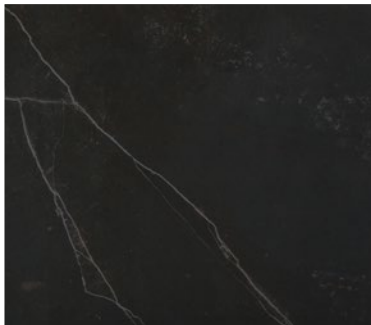

Kelya NATURAL Collection  

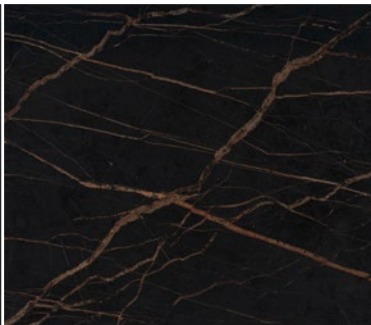

Laurent NATURAL Collection    *

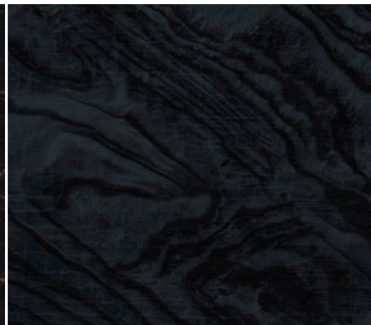

Liquid Embers LIQUID Collection 

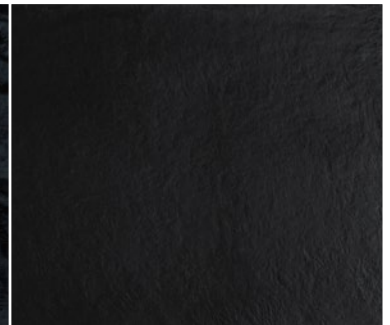

Sirius SOLID Collection  

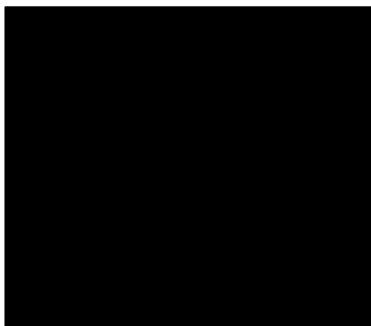

Domoos SOLID Collection 



The ultimate mineral
HybriQ® surface.

Silestone® is a hybrid surface made of minerals and recycled materials designed to bring colour and texture to interior spaces.

Silestone® Advantages

Silestone® is extremely durable in kitchens, bathrooms and other spaces exposed to constant activity and use. In addition, it offers an unlimited range of colours and textures.

Silestone® has many advantages, including low maintenance, high resistance to stains and scratches, and a low fluid absorption rate. This resistance to fluids and its minimal joints make Silestone® the ideal solution for places where liquids are present. Silestone® is hard-wearing and allows prolonged use over time to last a lifetime.

The properties of Silestone® are the result of constant years of innovation that guarantee maximum hygiene and safety.



Acid and scratch-resistant

Silestone® is highly resistant to scratches and impacts, as well as to external agents and acids common in everyday kitchen use.

Stain resistant

Silestone® is a non-porous surface that is highly resistant to stains from coffee, wine, lemon juice, oil, vinegar, make-up and many other everyday products.

Impact resistant

The high impact resistance of Silestone® allows for the handling of hard objects (pots, trays, etc.) with total peace of mind.



25 year
warranty

silestone®

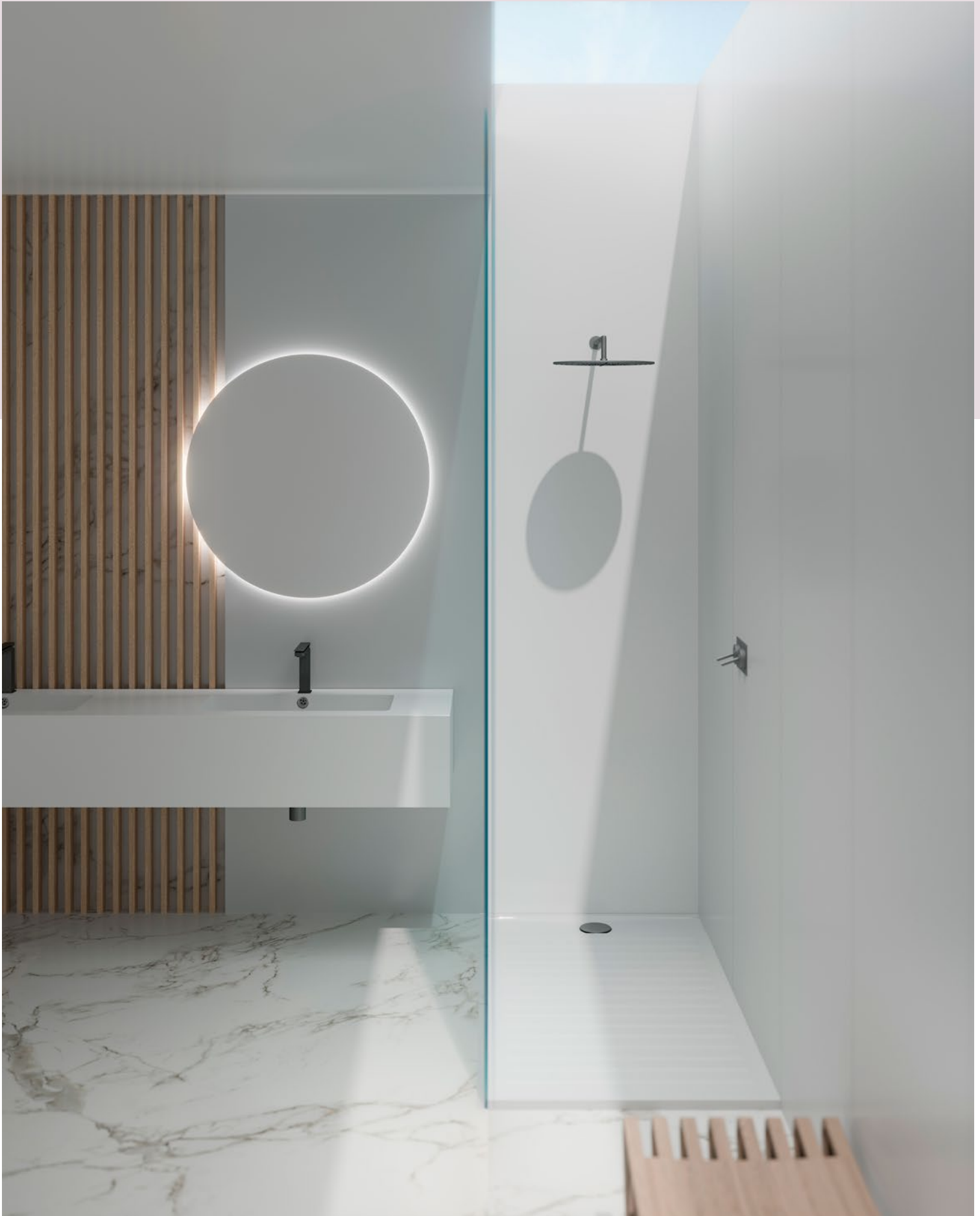

A new Silestone®

HybriQ+® Technology

A new high performance mix of premium minerals and recycled materials.

Produced through a sustainable manufacturing process that uses 99% recycled water and is entirely powered by renewable energy.

HYBRIQ+
TECHNOLOGY®

HybriQ+® is a pioneering technology developed and patented by Cosentino® for the manufacture of the new Silestone®.

Introducing the new Silestone® powered by HybriQ+® technology.



99%

Recycled
water



100%

Renewable
energy



0%

Water
discharge



At least 20%

Recycled
materials

See the available colours
with HybriQ+® Technology at www.cosentino.com

Silestone® formats

Many possibilities for indoor applications.

Silestone® is available in slabs measuring up to 3,250 x 1,590 mm and in tiles measuring 300 x 300 mm, 400 x 400 mm, 600 x 600 mm, 600 x 300 mm and 600 x 400 mm. They are marketed in thicknesses of 12, 20 and 30 mm. Furthermore, different pieces can be combined to simulate thicker edges.



Large format

Jumbo slabs → 3,250 x 1,590 mm
Standard slabs → 3,060 x 1,400 mm

Jumbo slabs

Cosentino® offers Silestone® slabs in Jumbo format (3,250 x 1,590 mm max.). This format allows large surfaces to be created with a minimum number of joints, design versatility and improved hygiene. This optimises the use of the slab and minimises waste.



Cladding format

- 300 x 300 mm
- 400 x 400 mm
- 600 x 600 mm
- 600 x 300 mm
- 600 x 400 mm
- Custom formats



Thicknesses

- 12 mm
- 20 mm
- 30 mm
- Custom thicknesses by combining different pieces together

Silestone® textures

Surface sensory perception.

In order to adapt to all styles, Silestone® comes in different textures for any of its applications. Polished, Suede or Volcano are three possibilities that let your imagination run wild and provide you with the worktops, floors or walls with the texture you have always wanted.

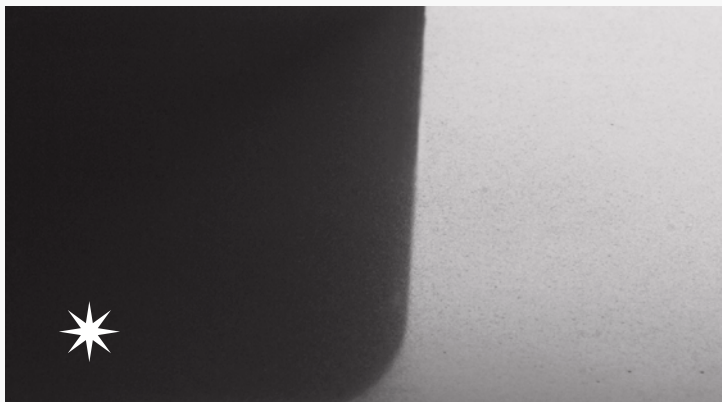

Polished

Extremely glossy and smooth texture with an intense and consistent colour.

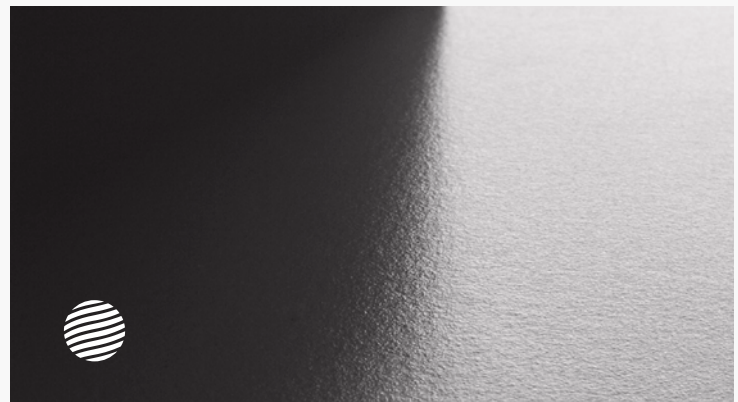

Suede

A matt finish which offers a unique soft and pleasant feel.

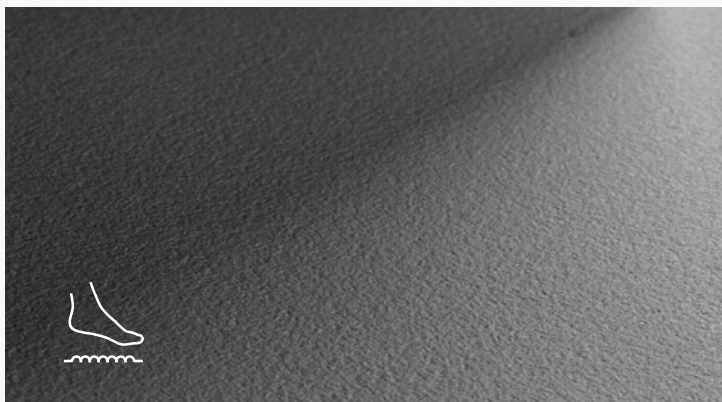

Soft sandblasted (Anti-slip)

Surface available exclusively in the shower tray range to guarantee maximum anti-slip safety.

Mediterranean Colour Shades

Sunlit Days Series

An immersive and sensory journey through light and colour that takes us back to our roots and leads us to a more natural, sustainable and humane future.

We are launching the first Silestone® Carbon Neutral collection, a commitment to sustainability in which we reduce and offset the emissions of the manufacturing process with reforestation projects. This environmental commitment results in a partnership programme for the preservation of the seabed and our environment.

Sunlit Days is inspired by the evocative Mediterranean shades of a unique lifestyle.

A new spirit. A new Silestone®.



Faro White

Cinzel Grey

Posidonia Green

Cala Blue

Arcilla Red

→ Countertop, wall cladding and flooring by Silestone®, Cala Blue colour / Marie Top washbasin by Silestone®, White Zeus colour



Ethereal collection

Introducing the Ethereal collection. An unparalleled leap in design, sustainability and innovation developed with HybriQ+® technology, which takes the concept of marble-style colours to a new dimension.

Ethereal, an evolution of our popular Eternal collection, interprets the dream-like beauty of the sky by tracing a deep, fine veining on a white foundation. The result: the most cutting-edge and avant-garde Silestone® series, a redefinition of veining that creates a new category in terms of performance and design.



Ethereal Noctis

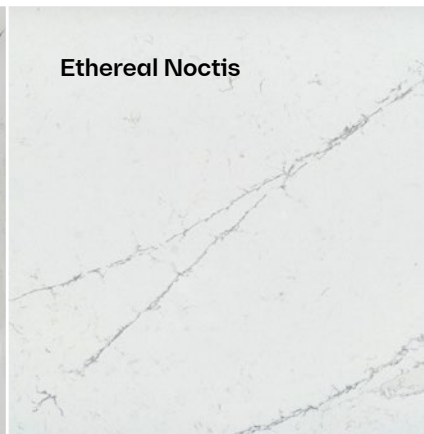

Ethereal Haze

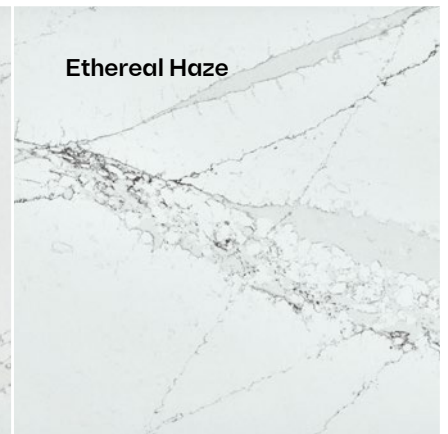

Ethereal Glow



Ethereal Dusk

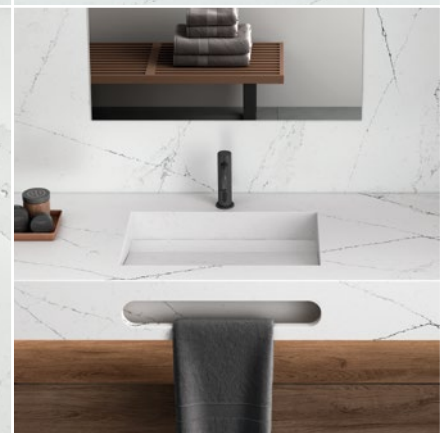
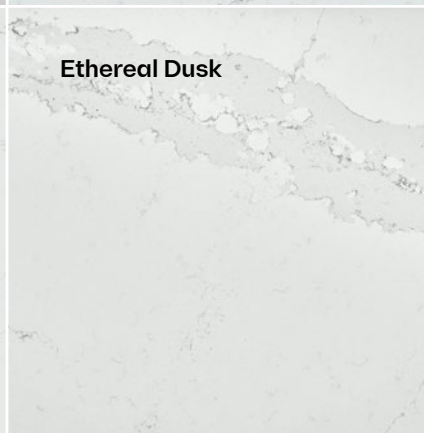

→ Countertop, wall cladding, washbasin and shower tray by Silestone®, Ethereal Noctis colour



Silestone® Collection



Faro White

Cincel Grey

Posidonia Green

Cala Blue

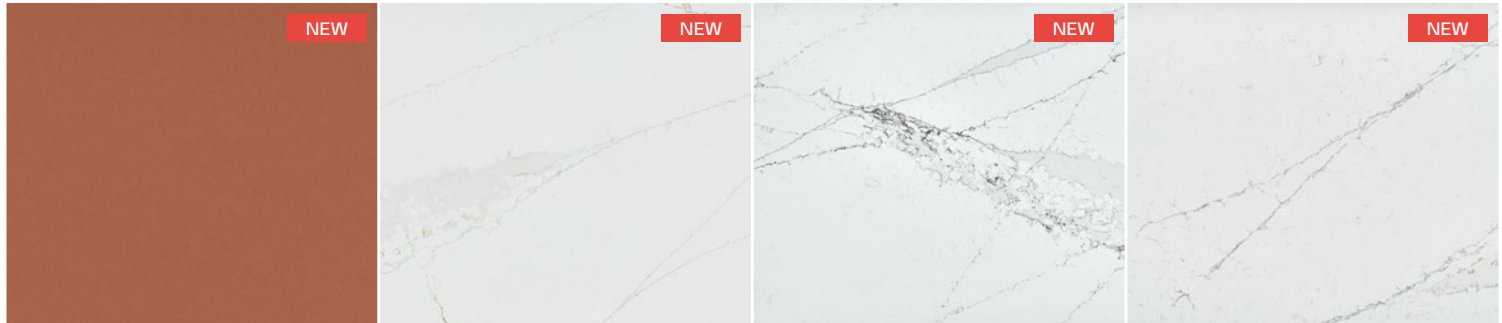

Arcilla Red

Ethereal Glow

Ethereal Haze

Ethereal Noctis



Ethereal Dusk

Iconic White

Blanco Zeus

Miami Vena

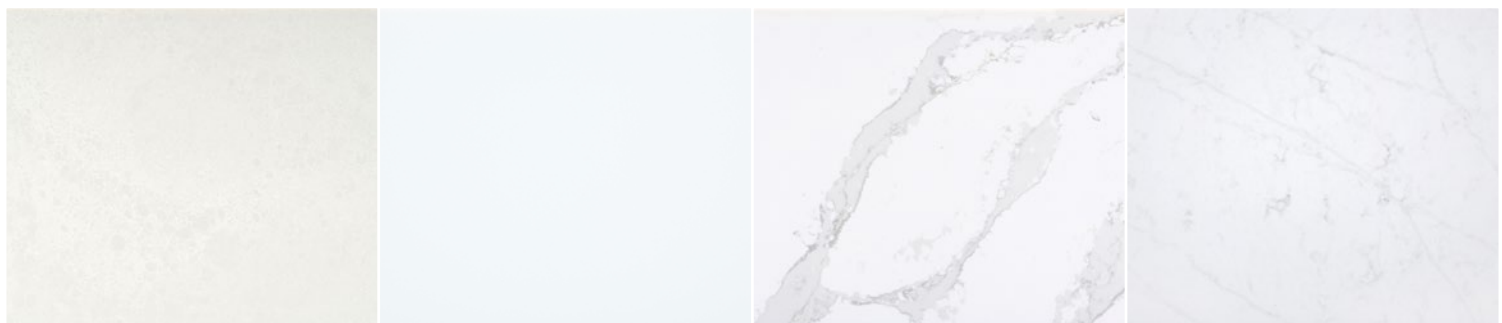

Nolita

Miami White 17

Et. Calacatta Gold

Et. Statuario

- ✱ POLISHED TEXTURE
- SUEDE TEXTURE
- ⊙ INTEGRITY®
- Ⓝ N-BOOST® TECHNOLOGY
- Ⓝ STANDARD SLAB
- Ⓝ JUMBO SLAB
- Ⓚ HYBRIQ® TECHNOLOGY
- Ⓚ+ HYBRIQ+® TECHNOLOGY



Ariel ⊙ ✱ ● ⊙

Blanco Maple 14 Ⓝ ⊙ ✱ ● ⊙

Blanco Norte 14 Ⓝ ⊙ ✱ ● ⊙

Blanco Stellar 13 Ⓝ ⊙ ✱ ● ⊙+ ⊙



Snowy Ibiza ⊙ ✱ ● ⊙

White Storm Ⓝ ⊙ ✱ ● ⊙

Yukon Ⓝ ✱ ● ⊙

Pearl Jasmine ⊙ ✱ ● ⊙



Desert Silver ⊙ ✱ ● ⊙

Lagoon Ⓝ ⊙ ✱ ● ⊙

Poble Nou ⊙ ● ⊙+

Niebla ⊙ ✱ ● ⊙

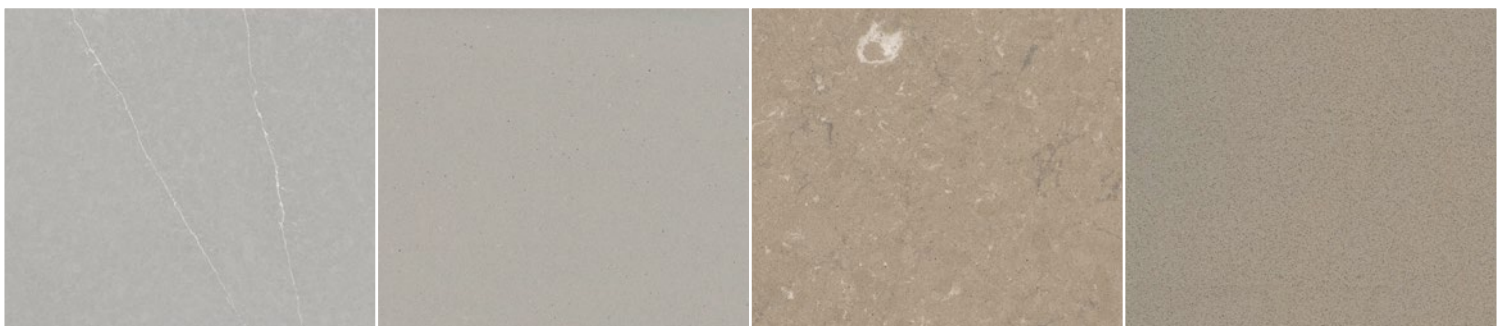

Et. Serena ⊙ ✱ ● ⊙

Camden ⊙ ● ⊙+

Coral Clay Colour ⊙ ✱ ● ⊙

Rougui Ⓝ ⊙ ✱ ● ⊙

Silestone® Collection

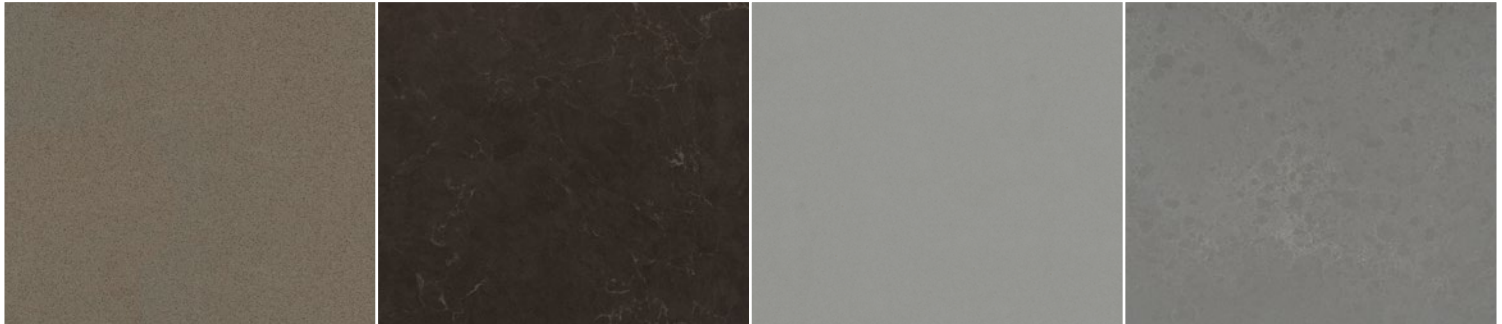

Noka

Calypso

Kensho

Seaport

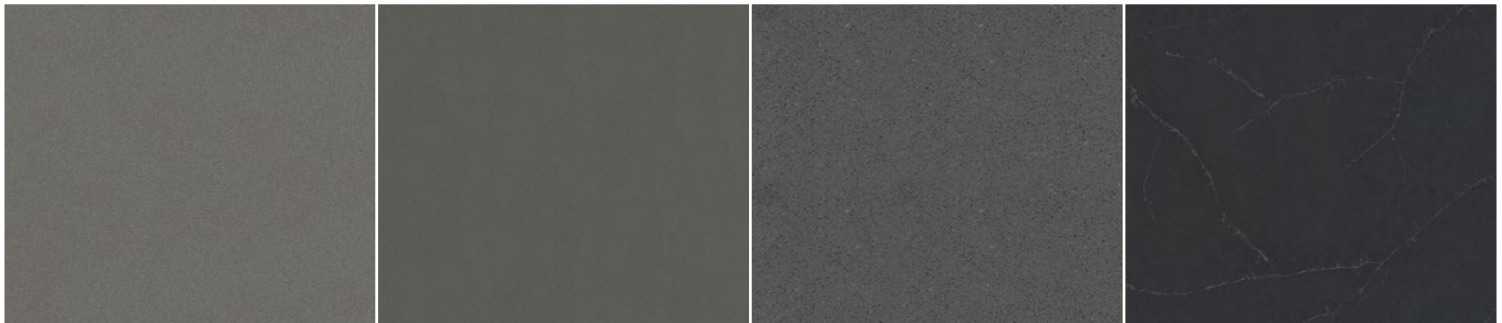

Gris Expo

Cemento Spa

Marengo

Charcoal Soapstone

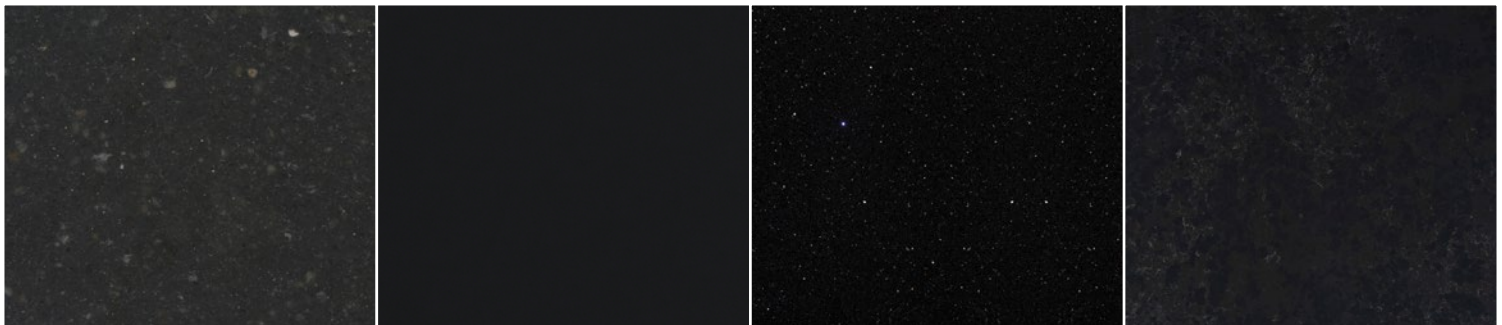

Arden Blue

Negro Tebas

Negro Stellar

Corktown

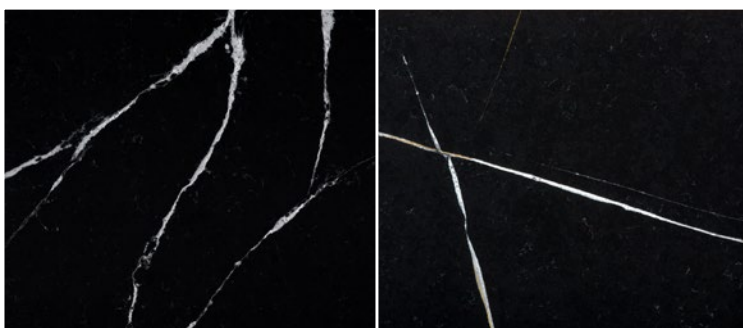

Et. Marquina

Eternal Noir

→ Countertop, wall cladding and Marie Top washbasins by Silestone®, Posidonia Green colour



SENSA

by COSENTINO®

Protected natural stone surface.

Sensa by Cosentino® is a premium, maintenance-free natural stone brought to you by Cosentino®, a world leader in the natural stone industry.

Sensa by Cosentino® is treated with a revolutionary stain-resistant treatment called SenGuard, and comes with a 15-year warranty against staining.

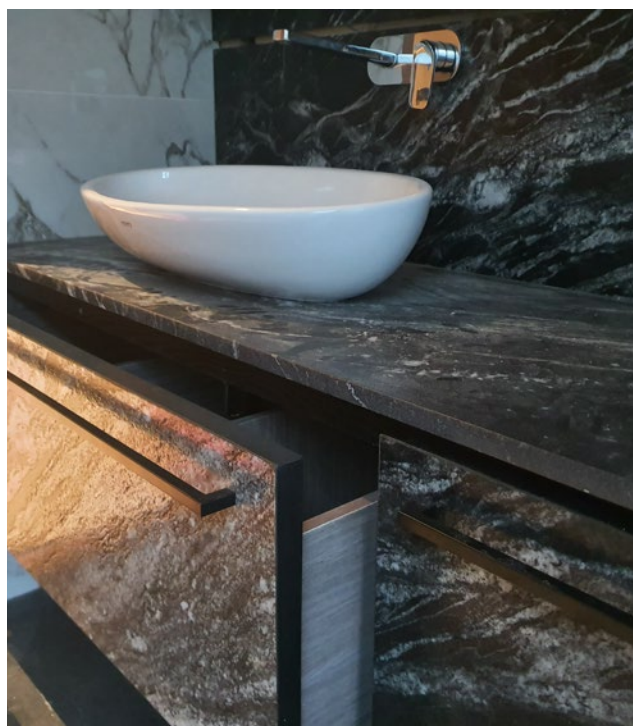

Applications

Sensa bathroom countertops. Stain-proof natural beauty.

Enjoy the design, durability and resistance of natural stone without worrying about stains. Sensa by Cosentino® quartzites and granites are treated with a revolutionary stain-resistant treatment that will protect your countertop and keep it looking as good as new.



Sensa by Cosentino® Treatment

Cosentino® applies an invisible, long-lasting treatment to quartzite and granite, which is chemically integrated into the material allowing it to breathe. This technology increases its powerful natural properties and prolongs its life.

The process changes the surface tension of the stone, enabling the material itself to prevent liquids from penetrating it.



SENSA
by COSENTINO®

Normal

Textures

Uniques shapes for one-of-a-kind surfaces.

The colours and textures of Sensa by Cosentino® features the patient and whimsical design of nature. Each of the available shades has a texture that produces different effects and sensations: suede, polished or caresse.



Sensa by Cosentino® Collection



Siberia ✪

Colonial White ✪

Taj Mahal ✪

White Macaúbas ✪

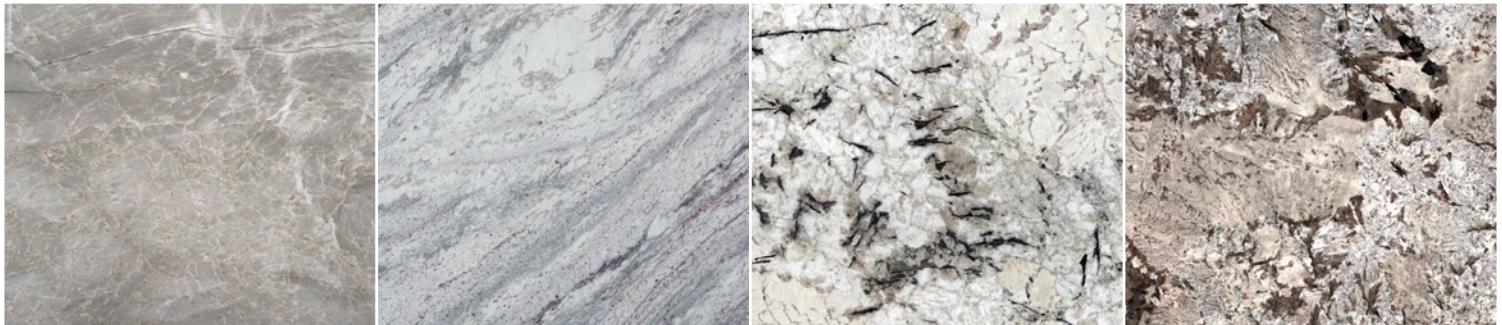

Vancouver ▨

San Angelo ▨

Ice Blue ✪

Glacial Blue ✪



Platino ▨

Silver Grey ✪

Indian Black ✪

Black Beauty ▨

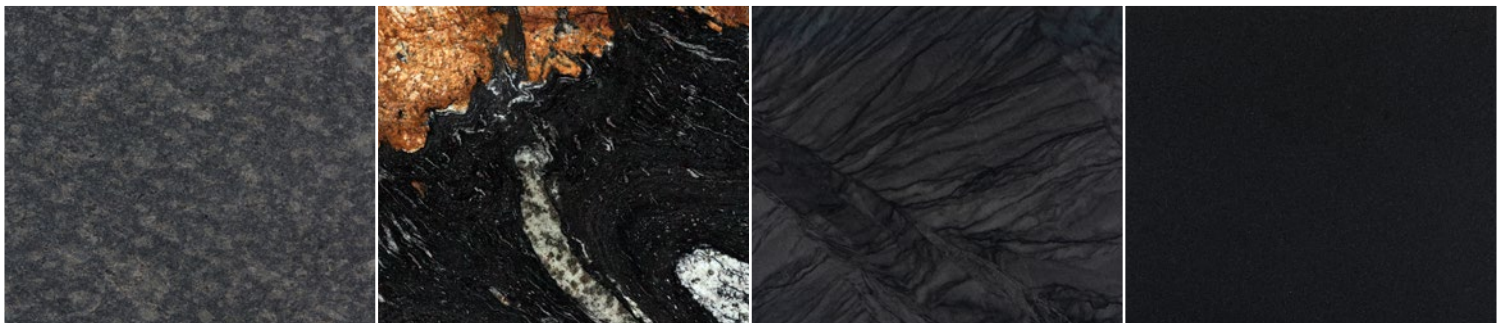

Graphite Grey ▨

Orinoco ✪

Nilo ✪

Moak Black ▨



Floor and wall cladding
in the same material
to unify spaces.

- 1→ Wall cladding by
Sensa, Vancouver colour
- 2→ Bathroom countertop by
Sensa, Vancouver colour

Washbasins

Full product range.

Designer washbasins and countertops suitable for any space.



Evita | Integrity®
Silestone®

58



Marie | Integrity®
Silestone®

60



Elegance
Silestone®

62



Armony
Silestone®

64



Symmetry
Silestone®

66



Simplicity
Silestone® | Dekton®

68



Reflection
Silestone® | Dekton®

70



Silence
Silestone® | Dekton®

72



HLine Flex
Silestone® | Dekton®

74



HLine Urban
Silestone® | Dekton®

76



HLine Bath Top
Silestone® | Dekton®

78

Evita

Integrity®

Three sizes of Integrity® washbasins with a round and functional design, which combine technology and integration, offering comfort for the most demanding solutions.

Washbasin made in Silestone®



Evita S



Evita L



Evita Q

Characteristics

- Moulded basin with Integrity® technology, without joints and with all corners rounded for easy cleaning.
- Optional overflow.
- Additional basins can be supplied and fitted.
- Countertop can be customised with a wide range of accessories such as towel rails, mortises, side legs (non-structural), additional drill holes, skirt height, etc.
- Click-clack valve included.
- Support bars included (for countertops with skirt).

Tap

With or without drill holes for taps

Overflow

With or without overflow

Edge

12 mm straight edge
125 mm skirt

Integrated basin

Standard S: 500 x 300 x 100 mm
Standard L: 650 x 300 x 100 mm
Standard Q: 510 x 410 x 100 mm

Countertop

Length: from 60 cm to 320* cm.
Width: from 40 cm to 60 cm.

* Jumbo slab only. For the maximum length, continuity of veins in the side skirts is not possible.

Available in a selection of Silestone® 12 mm colours in polished finish.

Scan the QR code to check the colours





Marie

Integrity®

The Integrity® washbasin is available in two different formats, on top of or integrated into the countertop, and two different sizes. Their soft corners and wide variety of finishes are perfect for all bathroom styles.

Washbasin made in Silestone®



Marie S



Marie L



Marie TOP S



Marie TOP L



Characteristics

- Moulded basin featuring Integrity® technology, without joints, with reduced height and rounded wall corners.
- TOP countertop washbasins models in exclusive matt finish.
- Additional basins can be supplied and fitted.
- Countertop can be customised with a wide range of accessories such as towel rails, mortises, side legs (non-structural), additional drill holes, skirt height, etc.
- Click-clack valve included.
- Support bars included (for countertops with skirt).

Tap

With or without drill holes for taps

Edge

20 mm straight edge
125 mm (integrated) /
10 mm (countertop basin) skirt

Integrated basin

Standard S: 340 x 370 x 70 mm
Standard L: 510 x 370 x 70 mm

TOP basin

Standard S: 340 x 370 x 100 mm
Standard L: 510 x 370 x 100 mm

Countertop

Length: from 470 to 3200* mm
Width: from 44 to 600 mm

*Jumbo slab only. For the maximum length, continuity of veins in the side skirts is not possible.

Available in a selection of Silestone® 20 mm colours, with a Polished or Suede finish (TOP version with a Matt finish).

Scan the QR code to check the colours





Elegance

Excellence in washbasins in pieces.
With the possibility of bespoke solutions
that provide uniform and elegant designs.

Made in Silestone®



Characteristics

- Traditional rectangular basin featuring a functional and thoughtful design.
- Optional overflow.
- Additional basins can be supplied and fitted.
- Countertop can be customised with a wide range of accessories such as towel rails, mortises, side legs (non-structural), skirt height, etc.
- Click-clack valve included.
- Support bars included (for countertops with skirt).

Tap

With or without
drill holes for taps

Overflow

With or without
overflow

Edge

20 mm straight edge
125 mm skirt

Integrated basin

Standard: 490 x 300 x 100 mm
Other sizes available for +20 pcs

Countertop

Length: from 590 to 3200* mm
Width: from 400 to 600 mm

* Jumbo slab only. For the maximum length,
continuity of veins in the side skirts is not possible.

Available in all Silestone®
20 mm colours, with a
Polished or Suede finish.

Scan the QR
code to check
the colours





Armony

The evolution of tradition turns this washbasin into the ideal touch for a distinctive bathroom, providing the harmony that the room needs.

Made in Silestone®



 silestone®



Characteristics

- Removable ramp for easy cleaning.
- Additional basins can be supplied and fitted.
- Countertop can be customised with a wide range of accessories such as towel rails, mortises, side legs (non-structural), additional drill holes, skirt height, etc.
- Suction cup to lift the ramp included.
- Grid sink plug valve included (cannot be closed).
- Support bars included (for countertops with skirt).

Tap

With or without drill holes for taps

Edge

20 mm straight edge
160 mm skirt

Integrated basin

Standard: 490 x 300 x 10 mm
Other sizes available for +20 pcs

Countertop

Length: from 590 to 3200* mm
Width: from 400 to 600 mm

* Jumbo slab only. For the maximum length, continuity of veins in the side skirts is not possible.

Available in all Silestone®
20 mm colours, with a
Polished or Suede finish.

Scan the QR code to check the colours





Symmetry

Innovative washbasin design with straight lines and reduced height, available in three different sizes, to provide the ideal solution for the most minimalist spaces.

Made in Silestone®



Characteristics

- Countertop washbasin suitable for countertops made of any material.
- Three sizes of basins to suit every need and every bathroom space.
- Countertop can be customised with a wide range of accessories such as towel rails, mortises, side legs (non-structural), skirt height, etc.
- Click-clack valve included.
- Support bars included (for countertops with skirt).

Tap

With or without drill holes for tap

Edge

20 mm straight edge
100 mm skirt

Under counter basin

Std. S: 330 x 230 x 70 mm (ext. 450 x 380 x 100 mm)
Std. M: 380 x 250 x 70 mm (ext. 500 x 400 x 100 mm)
Std. L: 580 x 300 x 70 mm (ext. 700 x 450 x 100 mm)
Other sizes available for +20 pcs

Optional countertop

Length: from 550 to 3200* mm
Width: from 430 to 600 mm

* Jumbo slab only. For the maximum length, continuity of veins in the side skirts is not possible.

Available in all Silestone®
20 mm colours, with a
Polished or Suede finish.

Scan the QR code to check the colours





Simplicity

A washbasin with a minimalist but practical design. Its modern and elegant lines make it a simple but smart choice for your bathroom.

Made in Silestone® and Dekton®



Characteristics

- Removable cover for easy cleaning.
- Fixed ramp with splash-proof slope
- Additional basins can be supplied and fitted.
- Countertop can be customised with a wide range of accessories such as towel rails, mortises, side legs (non-structural), skirt height, etc.
- Suction cup to lift the cover included.
- Grid sink plug valve included (cannot be closed).
- Support bars included (for countertops with skirt).

Tap

With or without drill holes for taps

Edge

20 mm straight edge for Silestone® /
12 mm straight edge for Dekton®
160 mm skirt

Under counter basin

Standard: 490 x 300 x 100 mm
Other sizes available for +20 pcs

Countertop

Length: from 590 to 3200* mm
Width: from 400 to 600 mm

* Jumbo slab only. For the maximum length, continuity of veins in the side skirts is not possible.

Available in all Silestone®
20 mm colours, with a
Polished or Suede finish,
and Dekton® 12 mm.

Scan the QR code to check the colours





Reflection

Innovative and versatile washbasin, with double drainage. Its innovative design, featuring straight lines, and its range of sizes provide the ideal solution to reflect your style in the bathroom.

Made in Silestone® and Dekton®



Characteristics

- Removable cover for easy cleaning.
- Double drainage slope, perfect for two taps.
- Additional basins can be supplied and fitted.
- Countertop can be customised with a wide range of accessories such as towel rails, mortises, side legs (non-structural), skirt height, etc.
- Suction cup to lift the cover included.
- Grid sink plug valve included (cannot be closed).
- Support bars included (for countertops with skirt).

Tap

With or without drill holes for taps

Edge

20 mm straight edge for Silestone®
/ 12 mm for Dekton®
125 / 160 mm skirt

Integrated basin

Standard S: 490 x 300 x 80 mm
Standard M: 900 x 300 x 80 mm
Standard L: 1200 x 300 x 80 mm
Other sizes available for +20 pcs

Countertop

Length: from 590 to 3200* mm
Width: from 400 to 600 mm

* Jumbo slab only. For the maximum length, continuity of veins in the side skirts is not possible.

Available in all Silestone®
20 mm colours, with a
Polished or Suede finish,
and Dekton® 12 mm.

Scan the QR
code to check
the colours





Silence

Washbasin with a design that provides both the warmth and tranquillity that the most relaxing bathroom seeks. A silent waterfall for ultimate well-being.

Made in Silestone® and Dekton®



Characteristics

- Linear drainage (not accessible for cleaning)
- Almost imperceptible drainage slope.
- Additional basins can be supplied and fitted.
- Countertop can be customised with a wide range of accessories such as towel rails, mortises, side legs (non-structural), skirt height, etc.
- Grid sink plug valve included (cannot be closed).
- Support bars included (for countertops with skirt).

Tap

With or without drill holes for taps

Edge

20 mm straight edge for Silestone® / 12 mm for Dekton®
125 / 160 mm skirt

Integrated basin

Standard S: 490 x 300 x 80 mm
Standard M: 900 x 300 x 80 mm
Standard L: 1200 x 300 x 80 mm
Other sizes available for +20 pcs

Countertop

Length: from 590 to 3200* mm
Width: from 400 to 600 mm

* Jumbo slab only. For the maximum length, continuity of veins in the side skirts is not possible.

Available in all Silestone® 20 mm colours, with a Polished or Suede finish and Dekton® 12 mm.

Scan the QR code to check the colours





HLine Flex

The perfect combination between a Silestone® or Dekton® countertop and an under counter ceramic washbasin, providing full functionality and ease of cleaning for your project.



 **silestone®**  **DEKTON®**

Characteristics

- Sanitary porcelain basin.
- Concealed overflow.
- Additional basins can be supplied and fitted.
- Countertop can be customised with a wide range of accessories such as towel rails, mortises, side legs (non-structural), skirt height, etc.
- Click-clack valve included.
- Support bars included (for countertops with skirt).

Tap

With or without drill holes for taps

Edge

20 mm straight edge for Silestone® / Dekton®
210 mm skirt

Under counter ceramic basin

Standard: 430 x 310 x 100 mm

Countertop

Length: from 600 to 3200* mm
Width: from 460 to 600 mm

* Jumbo slab only. For the maximum length, continuity of veins in the side skirts is not possible.

Available in all Silestone® 12 mm colours, with a Polished or Suede finish and Dekton® 12 mm colours.

Scan the QR code to check the colours





HLine Urban

A combination of Silestone® or Dekton® countertop and ceramic countertop washbasin, featuring a modern design and suitable for all needs.



 **silestone®**  **DEKTON®**

Characteristics

- Sanitary porcelain basin.
- Modern round design.
- Without overflow and tap ledge.
- Additional basins can be supplied and fitted.
- Countertop can be customised with a wide range of accessories such as towel rails, mortises, side legs (non-structural), skirt height, etc.
- Click-clack valve included.
- Support bars included (for countertops with skirt).

Tap

With or without drill holes for taps

Edge

12 mm straight edge for Silestone® / Dekton®
100 mm skirt

Top ceramic basin

Standard: Ø450 x 140 mm

Countertop

Length: from 450 to 3200* mm
Width: from 450 to 600 mm

* Jumbo slab only. For models with the maximum length, the side skirts do not show a continuous veining pattern.

Available in all Silestone®
12 mm colours, with a
Polished or Suede finish
and Dekton® 12 mm colours.

Scan the QR code to check the colours





HLine Bath Top

A new concept of bathroom countertops and shelves full of sophistication and elegance that you can customise to your taste to create that special place in your home.

Made in Silestone® and Dekton®

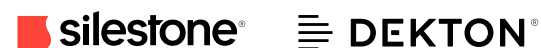

Characteristics

- Fully customisable: tap or drain drill holes for countertop washbasins, rough or polished cut-outs for recessed or under counter washbasins, etc.
- Suitable for use with basins made of any material.
- Elements can be placed individually.
- Countertop can be customised with a wide range of accessories such as towel rails, mortises, side legs (non-structural), skirt height, etc.
- Support bars included (for countertops with skirt).

Drill holes

With or without drill holes

Edge

12 mm straight edge for Silestone® / Dekton®
60 / 100 / 210 mm skirt

Basin

Without basin, suitable for combination with any other material.

Countertop

Length: from 600 to 3200* mm
Width: from 300 to 600 mm

* Jumbo slab only. For models with the maximum length, the side skirts do not show a continuous veining pattern.

Available in all Silestone®
12 mm colours, with a
Polished or Suede finish
and Dekton® 12 mm colours.

Scan the QR code to check the colours



Custom Design Operations

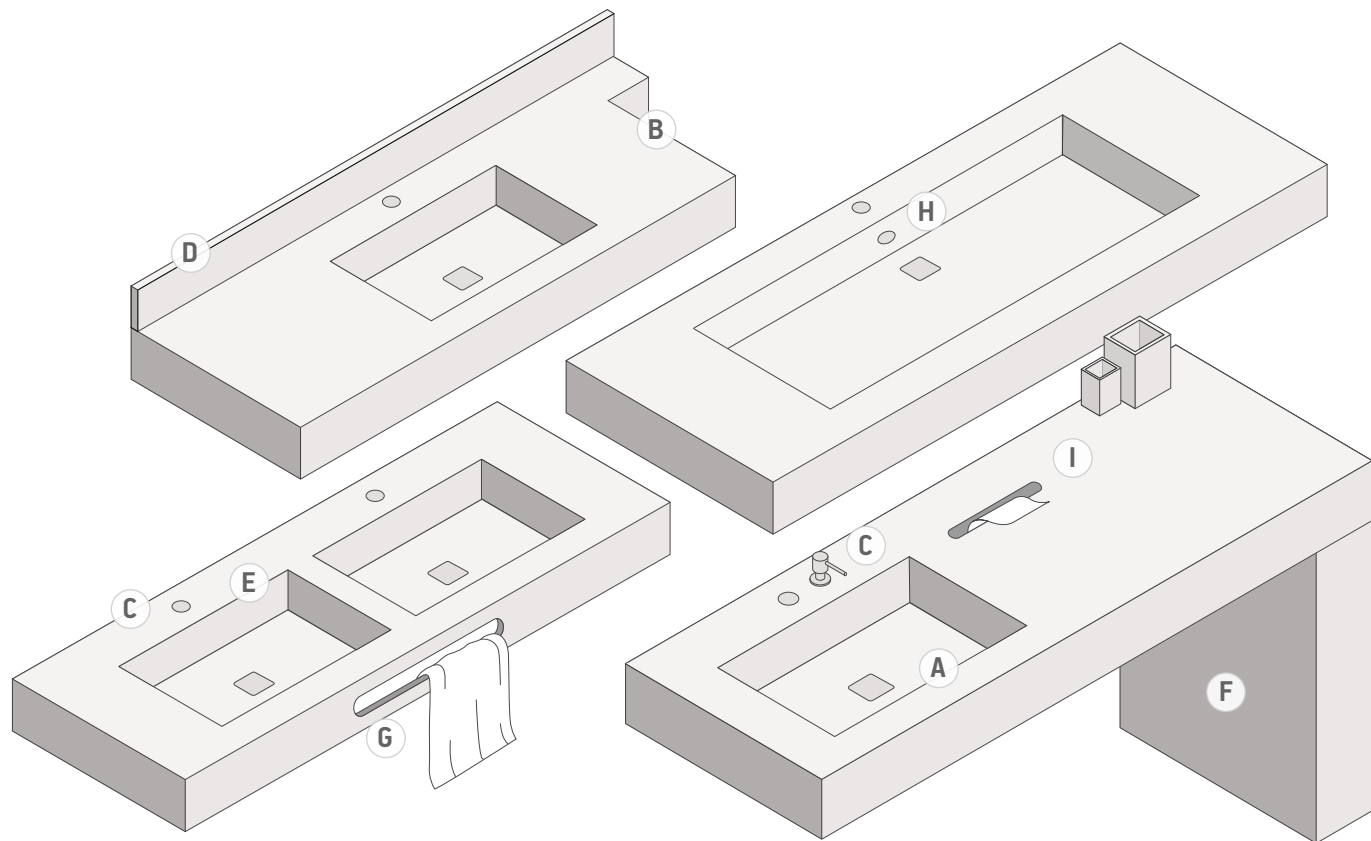

A Change in basin position.

B Mortises in the countertop to fit the space.

C Additional drill hole for tap/soap dispenser (1 pc. per extra basin is included).

D Custom-made trim.

E Additional basin.

F Waterfall edge with butt or mitre joint (maximum size 900 x 600 mm. Width according to standard washbasin skirt).

G Towel rail (distance between washbasin and edge must be ≥ 90 mm).

Small: 400 x 50 mm
Medium: 600 x 50 mm
Large: 800 x 50 mm

H Overflow.

I Groove and cut-out for tissue box (200 x 50 mm).

Customised operations

Polished cut-out (for under countertop washbasin up to 600 x 400 mm).

Rough cut-out (up to $\varnothing 80$ mm, for countertop washbasin drain).

Extra cover

Simplicity and Reflection.



Washbasin
installation
guide.



Access the guide by scanning the QR code

Shower trays

Full product range.

Five models of customisable shower trays in a wide range of colours and finishes, which adapt to any space and technical requirement, no matter how complicated it may seem.

Gocce

Our new design – simpler and more functional – suits any space.



Gocce
Dekton® Grip+

82



Exelis
Silestone®

94

Kador Suite
Silestone®

86



Wakka
Silestone®

88

Wakka Brim
Silestone®

90

Gocce

The new generation of shower trays is here. A highly stylised design, with gentle slopes and a pleasant and delicate non-slip texture for your feet.

Made in Dekton®



Characteristics

- Extra-flat (28 mm) and ultra light (25 kg/m²) tray.
- Anti-slip treatment on the material.
- Available in various standard formats and colours.
- Possibility to adapt the dimensions of the standard shower tray with two-sided or four-sided* factory cut-outs.
- Prior analysis of the colour, other Dekton® Grip+ colours are available with a minimum order quantity of 60 pcs.
- Optional on-site cut-outs for easy adaptation.
- Installation flush with the floor or on top.
- Valve with siphon and stainless steel grid included.

Valve

Centred or offset (fixed)

Perimeter area

Flat surface with no slope for optimum positioning of the shower screen

Edge

28 mm straight polished edge for Dekton®

Shower tray*

Length: from 1200 to 1800 mm
Width: from 700 to 900 mm

* Customised product subject to certain fixed maximum and minimum measurements.

Surface

Dekton® Grip+ anti-slip finish for barefoot use (Class C, DIN 51097)

Available in a range of Dekton® Grip+ 8 mm colours.

Scan the QR code to check the colours





Exelis

A simple but robust design, with a four-way drainage system suitable for any need. Its textured finish gives the shower tray the highest anti-slip properties.

Made in Silestone®



 **silestone®**



Characteristics

- Standard 40 mm perimeter zone with elegant round corners of 60 mm radius.
- Possibility to change the position of the valve where needed (depending on the dimension of the tray).
- Optional cut-outs to suit space available on request.
- Optional side slot for shower screen installation.
- Installation flush with the floor or on top.
- Valve with siphon and stainless steel shower drain included.

Valve

Customisable positioning.

Perimeter area

40 mm flat surface for optimum positioning of the shower screen.

Edge

30 mm straight polished.

Shower tray

Length: from 700 to 3200* mm
Width: from 700 to 1500* mm

* Jumbo slab only. N-Boost treatment is not applied to sandblasted areas.

Surface

Sandblasted anti-slip finish all over (Class C, DIN 51097)

Available in all Silestone®
30 mm colours, with a
Polished or Suede finish.

Scan the QR code to check the colours





Kador Suite

Its perimeter, fully framed, ensures perfect leak tightness during showering. Drainage slope to a full-width linear water collection area.

Made in Silestone®



silestone®



Characteristics

- Standard perimeter frame 50 mm high and 20 mm wide, which can be extended to 34 or 50 mm wide.
- Soft sandblasted strips for easy cleaning.
- Additional drain cover available.
- Optional cut-outs to suit space available on request.
- Optional side slot for shower screen installation.
- Installation flush with the floor or on top.
- Valve with siphon and stainless steel shower drain included.

Valve

In the centre of one side

Extra cover

Over the drainage area.

Perimeter frame

20 mm flat surface for optimum positioning of the shower screen.

Edge

50 mm straight polished.

Shower tray

Length: from 700 to 2000 mm
Width: from 700 to 1500* mm

* Jumbo slab only. N-Boost treatment is not applied to sandblasted areas.

Surface

Sandblasted strips (Class C, DIN 51097).

Available in all Silestone® 20 mm colours, with a Polished or Suede finish.

Scan the QR code to check the colours



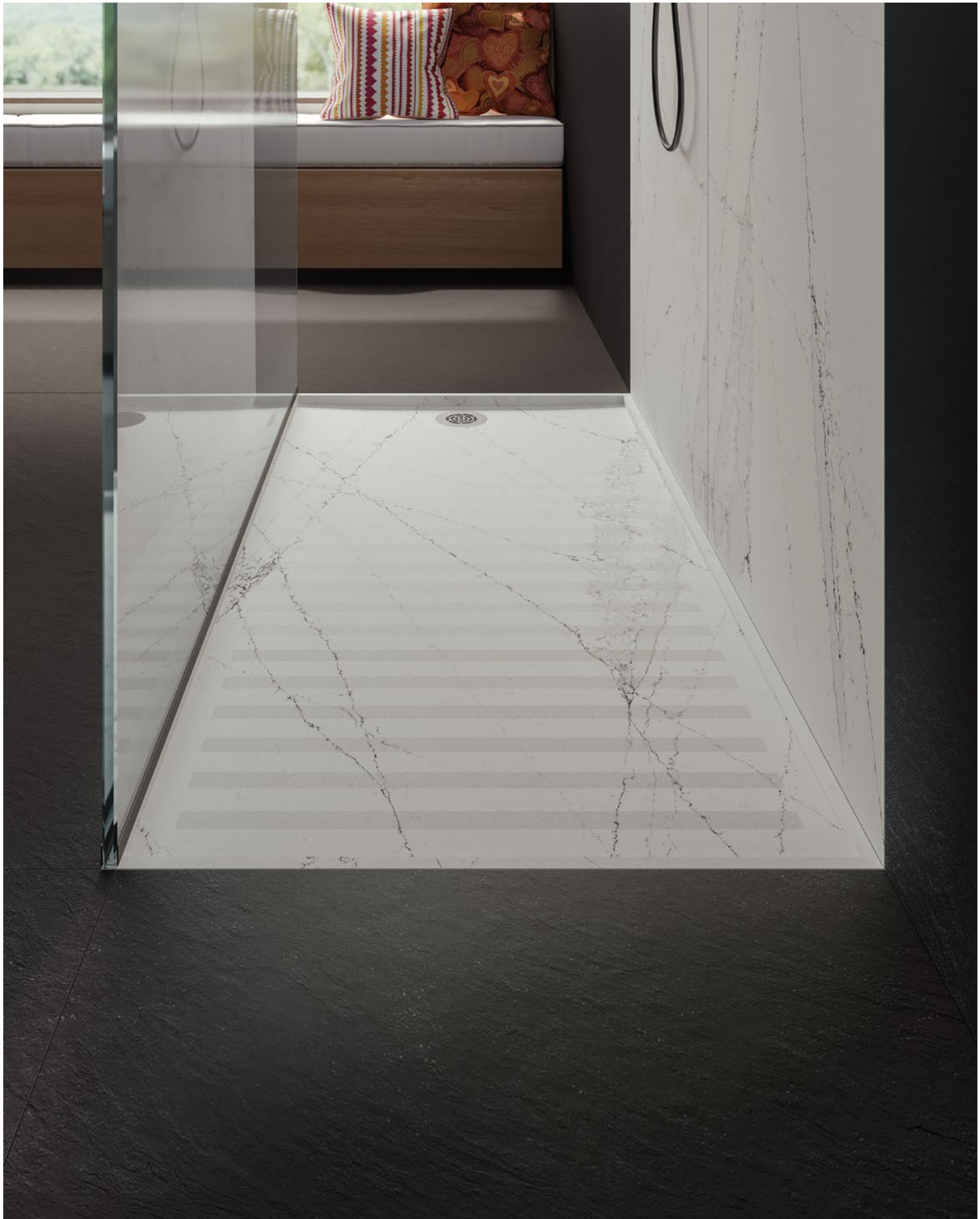

Wakka

Made in one piece, without vertical joints. Its single slope makes it functional and easy to fit into the bathroom floor, providing a simple, practical and elegant design.

Made in Silestone®



 **silestone®**

Characteristics

- Made in one piece, with no additional material that would require vertical joints.
- Designed for integration and continuity with the surrounding elements.
- Soft sandblasted strips for easy cleaning.
- Optional cut-outs to suit space available on request.
- Installation flush with the floor (recessed).
- Valve with siphon and stainless steel grid included.

Valve

In the centre of one of the short sides.

Long sides

15 mm flat surface for optimum positioning of the shower screen.

Edge

Decreasing edge from 30 to 5 mm.

Shower tray

Length: from 700 to 2500* mm
Width: from 700 to 1500* mm

* Jumbo slab only. N-Boost treatment is not applied to sandblasted areas.

Surface

Sandblasted strips (Class C, DIN 51097).

Available in all Silestone®
30 mm colours, with a
Polished or Suede finish.

Scan the QR code to check the colours





Wakka Brim

An eye-catching tray, with a sophisticated and technological look suitable for all uses. Choose a Wakka tray with two additional side frames, without vertical joints.

Made in Silestone®



 **silestone®**

Characteristics

- Tray with two side frames, with a subtle chamfer towards the interior to facilitate water collection.
- Disruptive and innovative design compared to traditional shower trays.
- Soft sandblasted strips for easy cleaning.
- Extra cover for the drainage area available.
- Optional cut-outs to suit space available on request.
- Installation flush with the floor or on top.
- Valve with siphon and stainless steel shower drain included.

Valve

In the centre of one of the short sides.

Extra cover

Over the drainage area

Side frames

25 mm flat surface for optimum positioning of the shower screen.

Edge

30 mm straight polished.

Shower tray

Length: from 700 to 2500* mm
Width: from 700 to 1500* mm

* Jumbo slab only. N-Boost treatment is not applied to sandblasted areas.

Surface

Sandblasted strips (Class C, DIN 51097).

Available in all Silestone®
30 mm colours, with a
Polished or Suede finish.

See colours by scanning the QR code



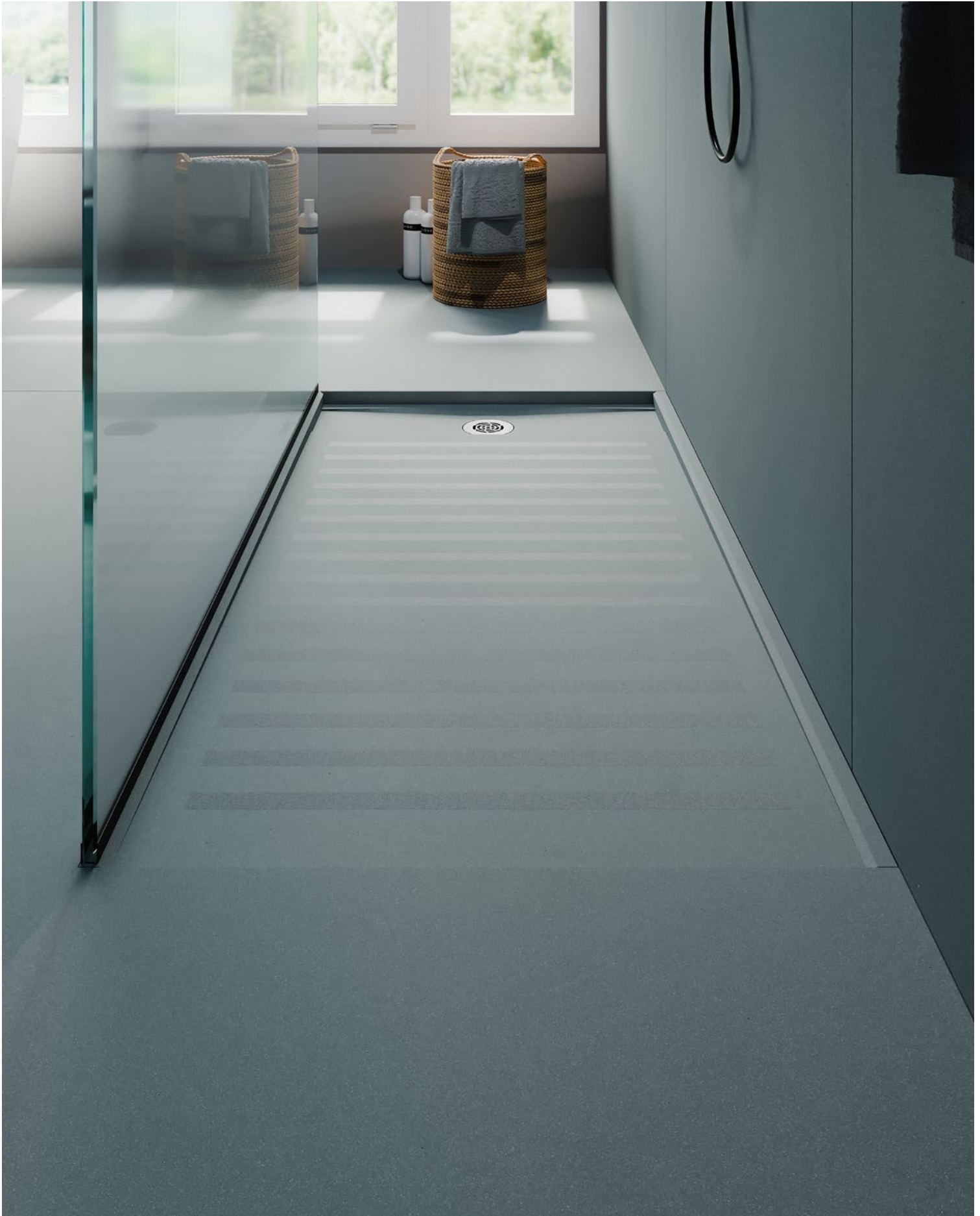

Customised operations

Silestone®

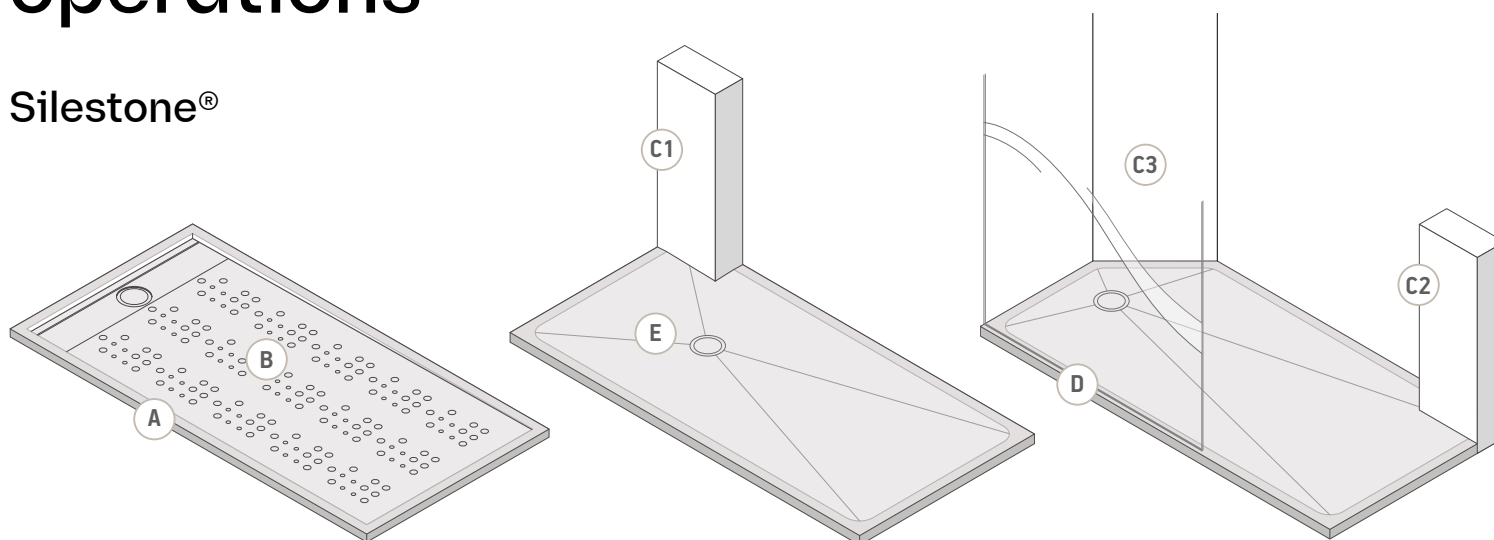

A Kador Suite: Perimeter frame (30, 40 or 50 mm) for shower screen fitting

B Kador Suite: customisable sandblasting, subject to slip analysis.

C1 Exelis: Straight cut in the shower tray valve area to suit the space

C2 All: Straight cut in the rear area of the shower tray to suit the space

C3 All: Diagonal cut in the shower tray to suit the space

D Kador Suite and Exelis: Side cut-out for shower screen installation.

E Exelis: Change of valve position (subject to certain limits)

Extra cover
Kador Suite and Wakka Brim.

Dekton®

Off-centre valve

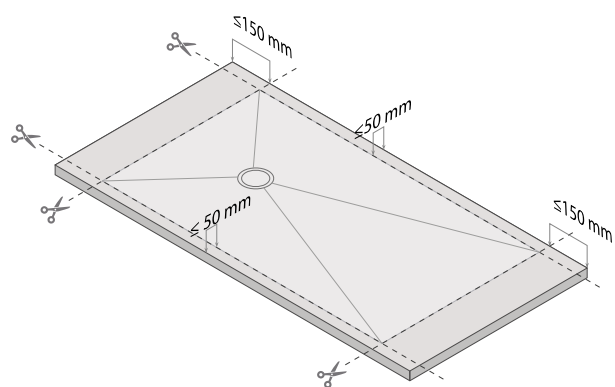

A Up to two straight cuts (in width and/or length)

B Up to four straight cuts (in width and length)

Centred valve

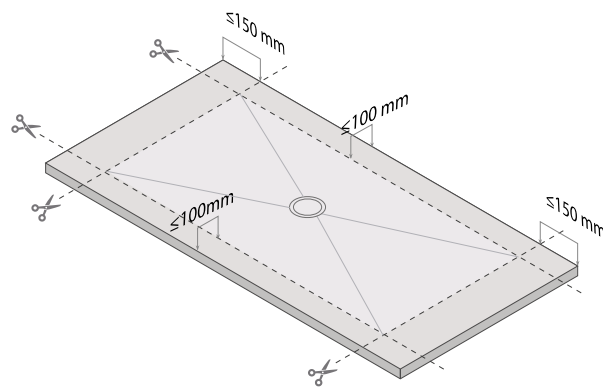



Washbasin
installation guide.



Access the guide
by scanning the
QR code

Designs to disconnect

Be inspired

Cosentino Bathroom Collection

Re-imagine the
most personal
space in your home

Very versatile materials

Contemporary, industrial, minimalist,
artisan, Nordic, Mediterranean...
any bathroom style is possible with
Cosentino® surfaces and finishes. The
latest trends with maximum performance.





Contemporary, fresh
and elegant luxury for
a modern bathroom.



- 1→ Countertop and splashback by Silestone®, White Zeus colour
- 2→ Elegance washbasin by Silestone®, White Zeus colour







Large format, cream coloured surfaces unify the space and bring warmth.

- 1→ Floor and wall cladding by Dekton®, Nacre colour
- 2→ Evita L washbasin by Silestone®, White Zeus colour
- 3→ Gocce shower tray by Dekton® Grip+, Nacre colour
- 4→ Bathroom countertop by Silestone®, White Zeus colour







Tone combination
in an elegant and
industrial finish.



- 1→ Floor and wall cladding by Dekton®, Lunar colour
- 2→ Bathroom countertop by Silestone®, Negro Tebas colour
- 3→ Symmetry S washbasin by Silestone®, Negro Tebas colour

Custom showers
and shower trays in
the same material
as the floor.

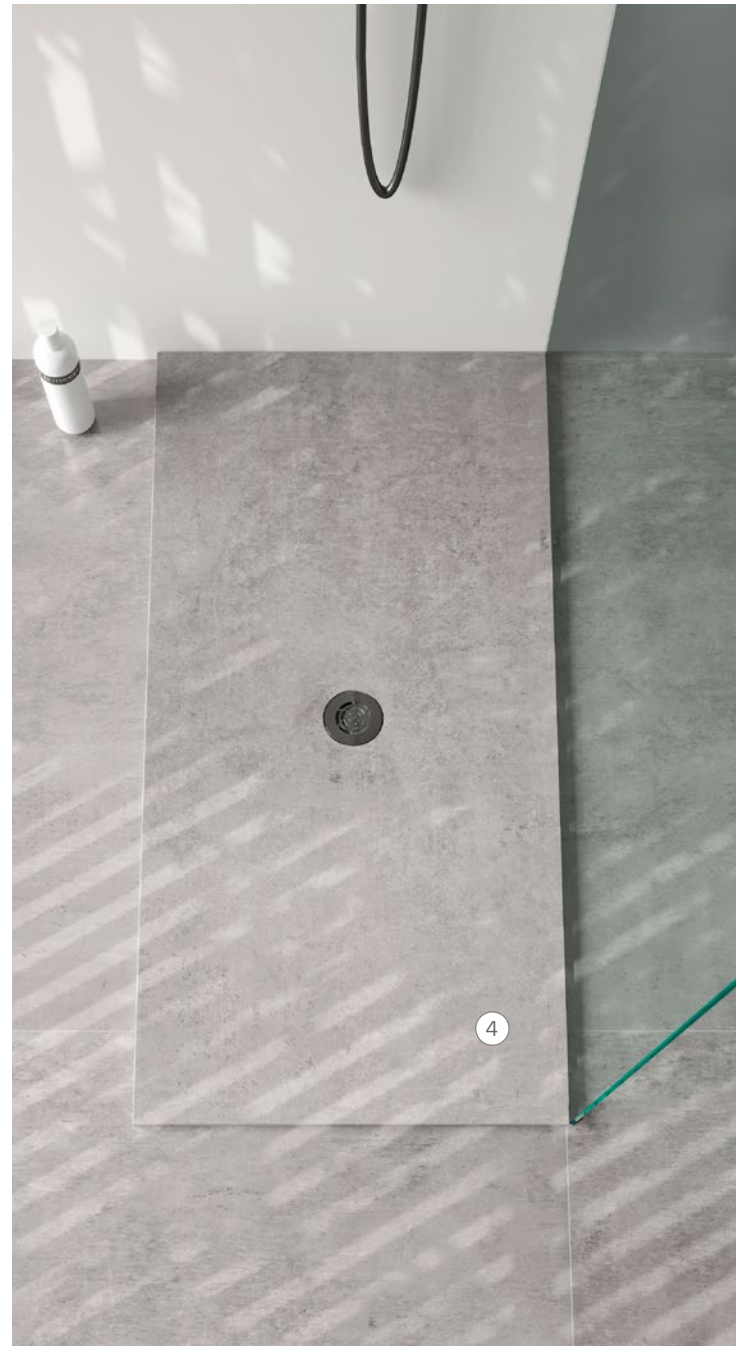

- 1→ Bathroom countertop by Silestone®, White Zeus colour
- 2→Floor and wall cladding by Dekton®, Kreta colour
- 3→Evita S washbasin by Silestone®, White Zeus colour
- 4→Gocce shower tray by Dekton® Grip+, Kreta colour



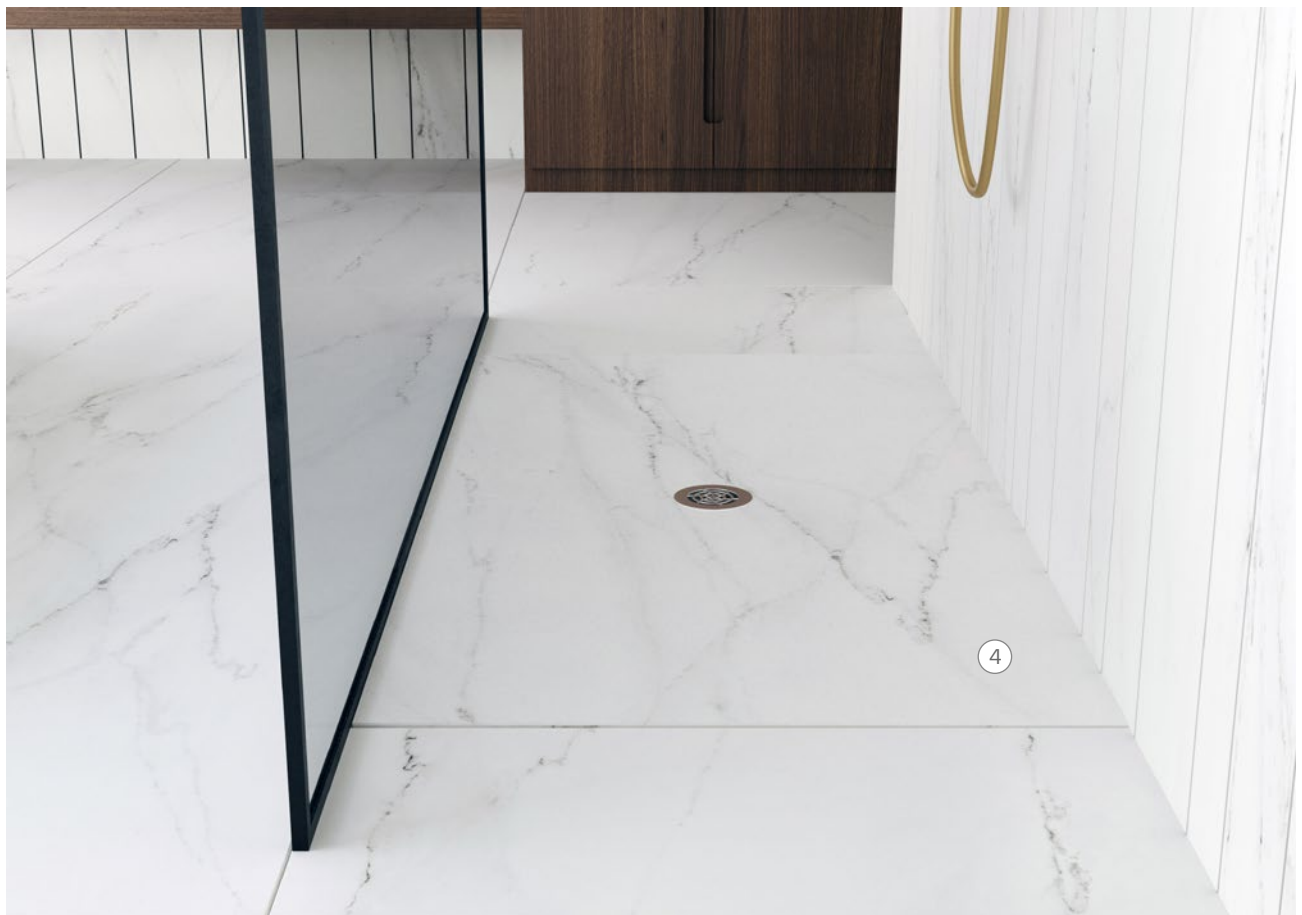
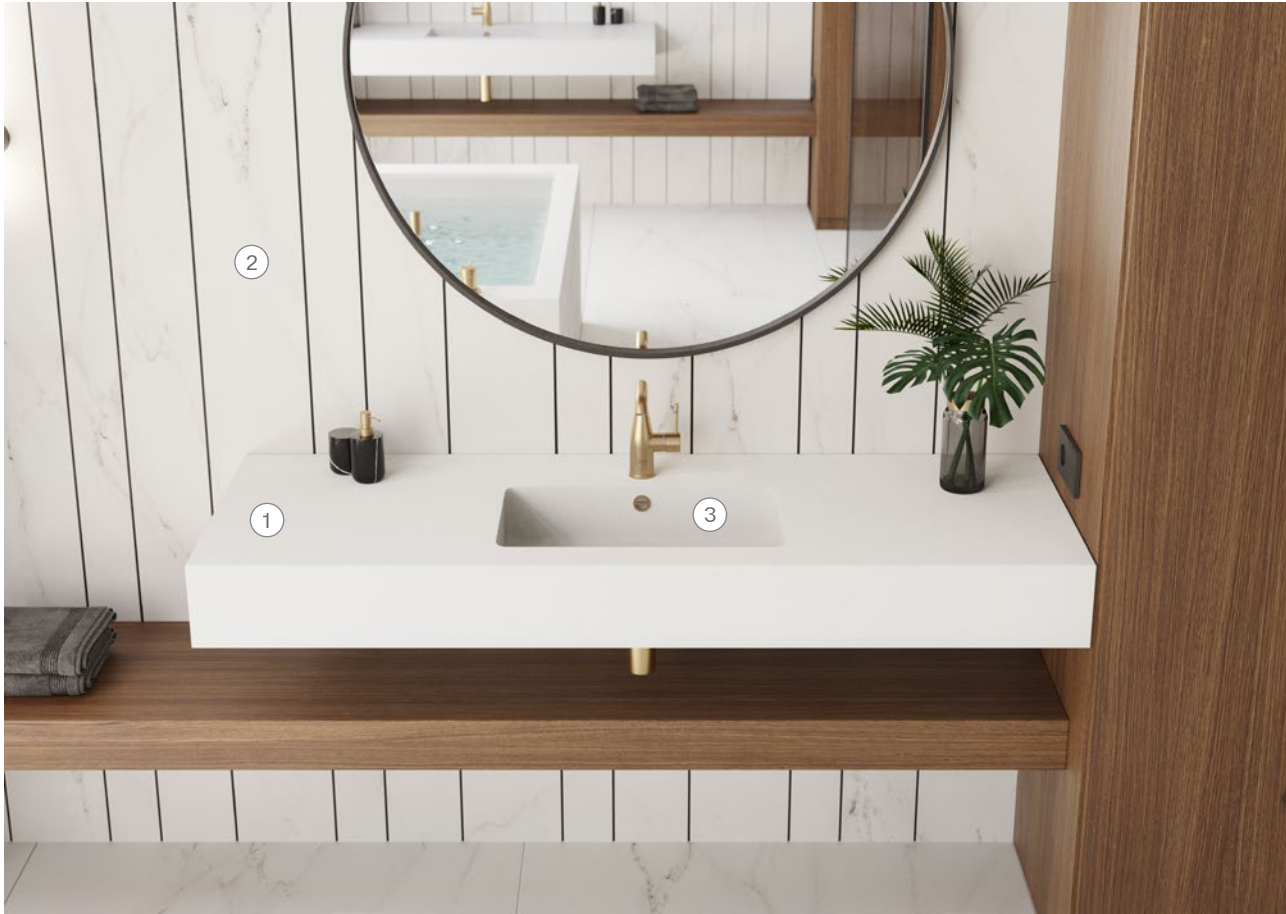



When naturalness is key, the most eclectic elements co-exist in perfect harmony.

- 1→ Bathroom countertop by Silestone®, White Zeus colour
- 2→ Wall cladding by Dekton®, Rem colour
- 3→ Evita S washbasin by Silestone®, White Zeus colour
- 4→ Gocce shower tray by Dekton® Grip+, Rem colour

The most beautiful patterns in nature with the latest technology.

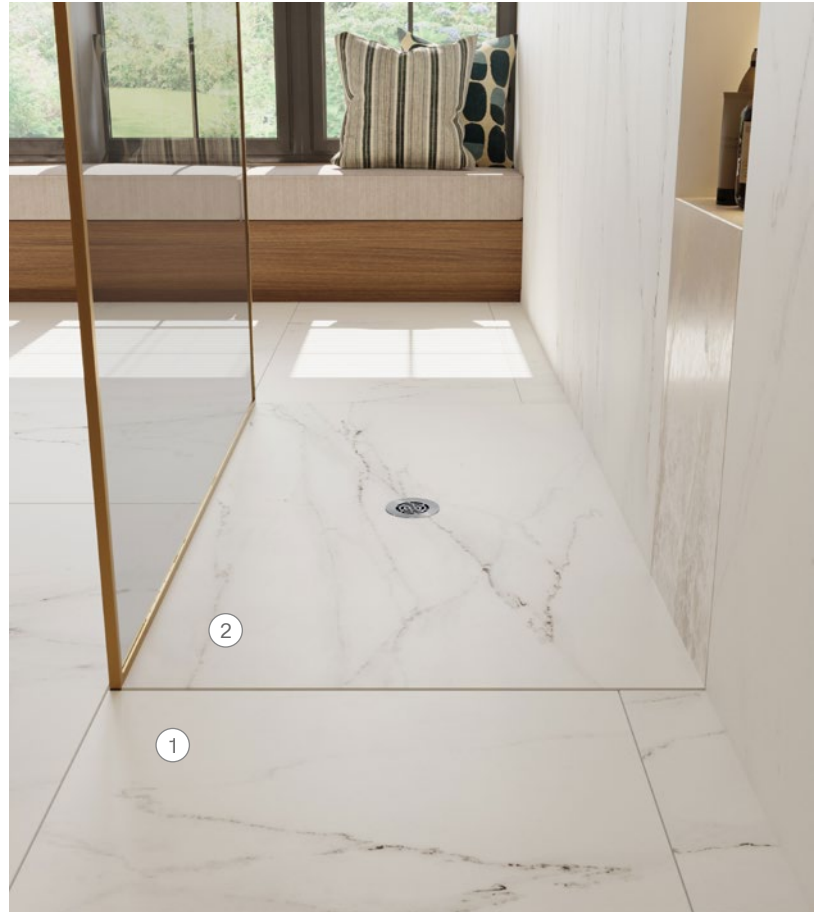

- 1→ Floor and wall cladding by Dekton®, Rem colour
- 2→ Gocce shower tray by Dekton® Grip+, Rem colour
- 3→ Bathroom countertop by Silestone®, White Zeus colour
- 4→ Evita S washbasin by Silestone®, White Zeus colour





Reinterpreting the industrial style: cement and veining enjoy harmonious interpretation.



- 1→ Bathroom countertop by Silestone® Charcoal Soapstone
- 2→ Custom shower tray by Dekton® Grip+, Kreta colour
- 3→ Floor cladding by, Dekton®, Kreta colour
- 4→ Marie Top L washbasin by Silestone®, White Zeus colour



A personal, urban style with classic references and the most technologically innovative materials.

- 1→ Countertop and wall cladding by Dekton®, Eter colour
- 2→ Symmetry washbasin by Silestone®, Negro Tebas 18 colour



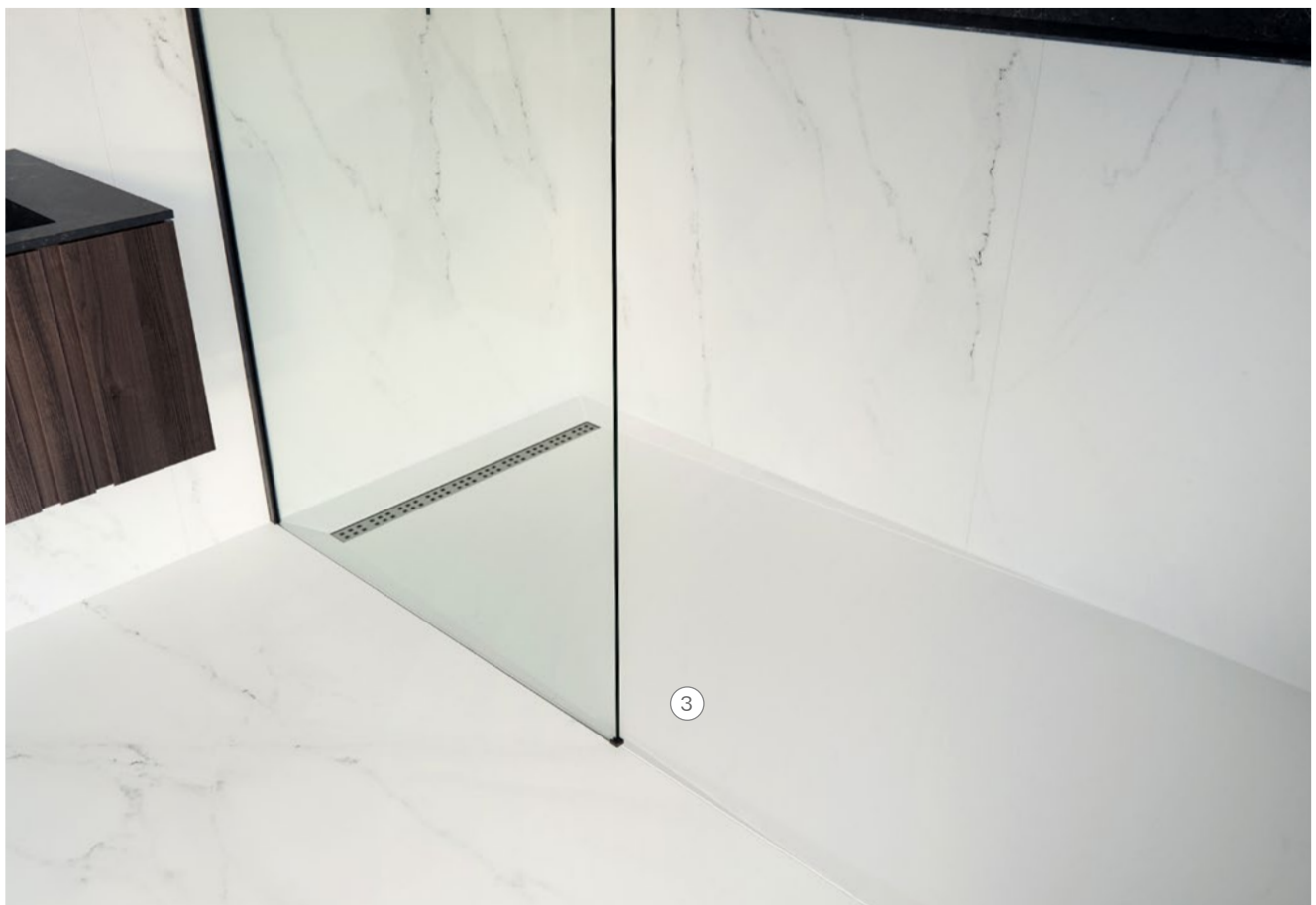



Plain and bare
bathroom: purity of
lines, neutral colours
and balance of shapes.

- 1→ Floor and wall
cladding (Optimma Format)
by Dekton®, Rem colour
- 3→ Bathroom countertop by
Silestone®, Corktown colour
- 3 → Custom shower tray:
Dekton® Zenith
- 4→ Silence L wasbasin by
Silestone®, Corktown colour

Accessories

Accessories for washbasins



**Round click-clack
basin waste⁽¹⁾**

Washbasins:

Evita, Marie, Elegance, Symmetry,
HLine Flex and HLine Urban

Technical information:

Outlet connection: Ø32 mm (1 1/4")
Water flow: Qmax. 43 l/m

Code: 307383



**Colour adapter for
washbasin valve**

Washbasins:

Evita, Marie, Elegance, Symmetry,
HLine Flex and HLine Urban

Technical information:

Outside diameter: 62 mm
Inner diameter: 30 mm
Overflow: compatible

Code: 347138 (Matt Black), 347153 (Brushed
gold) and 347154 (Brushed nickel)



**Flat
waste strainer⁽¹⁾**

Washbasins:

Armony, Simplicity, Reflection and Silence

Technical information:

Outlet connection: Ø32 mm (1 1/4")
Water flow: Qmax. 43 l/m

Code: 341538



Overflow adapter⁽²⁾

Washbasins:

Elegance and Evita

Technical information:

Max. length 300 mm (11 4/5")
Water flow: Qmax. 43 l/m

Code: 324644



**Colour adapter
for overflow**

Washbasins:

Elegance y Evita

Technical information:

Max. length 320 mm (12 3/5")
Water flow: Qmax. 43 l/m

Code: 347147 (Matt Black), 347139
(Brushed gold) and 347129 (Brushed
nickel)



Telescopic support bar⁽³⁾

Washbasins:

Elegance, Armony, Symmetry, Simplicity,
Reflection, Silence, Evita, Marie, HLine Flex/
Urban and Bath Top.

Technical information:

length without extension: 355 mm (14")
length with extension: 610 mm (24")
Height: 60 mm (2 1/2") / Width: 40 mm (1 3/5")
Anchor plate: 90 x 110 x 5 mm
(3 1/2 x 4 1/3 x 1/5")

Code: 347265

Accessories for shower trays



Shower tray valve with removable grate and siphon ⁽⁴⁾

Shower trays:

Gocce, Exelis, Kador Suite, Wakka and Wakka Brim

Technical information:

Outlet connection: Ø40 mm (1 1/2") x 115 mm

Water flow: Qmax. 43 l/m

Siphon: 30 mm

Code: 339708

- ⁽¹⁾Chrome valve supplied with the basin.
- ⁽²⁾Adapter supplied when ordering an overflow as an extra.
To be specified at the point of order when required.
- ⁽³⁾Two supports supplied when ordering a washbasin with skirt.
An additional support will be included for each additional basin ordered, at no extra cost. If more supports are required, please include them manually in the order.
- ⁽⁴⁾Valve supplied with each shower tray.

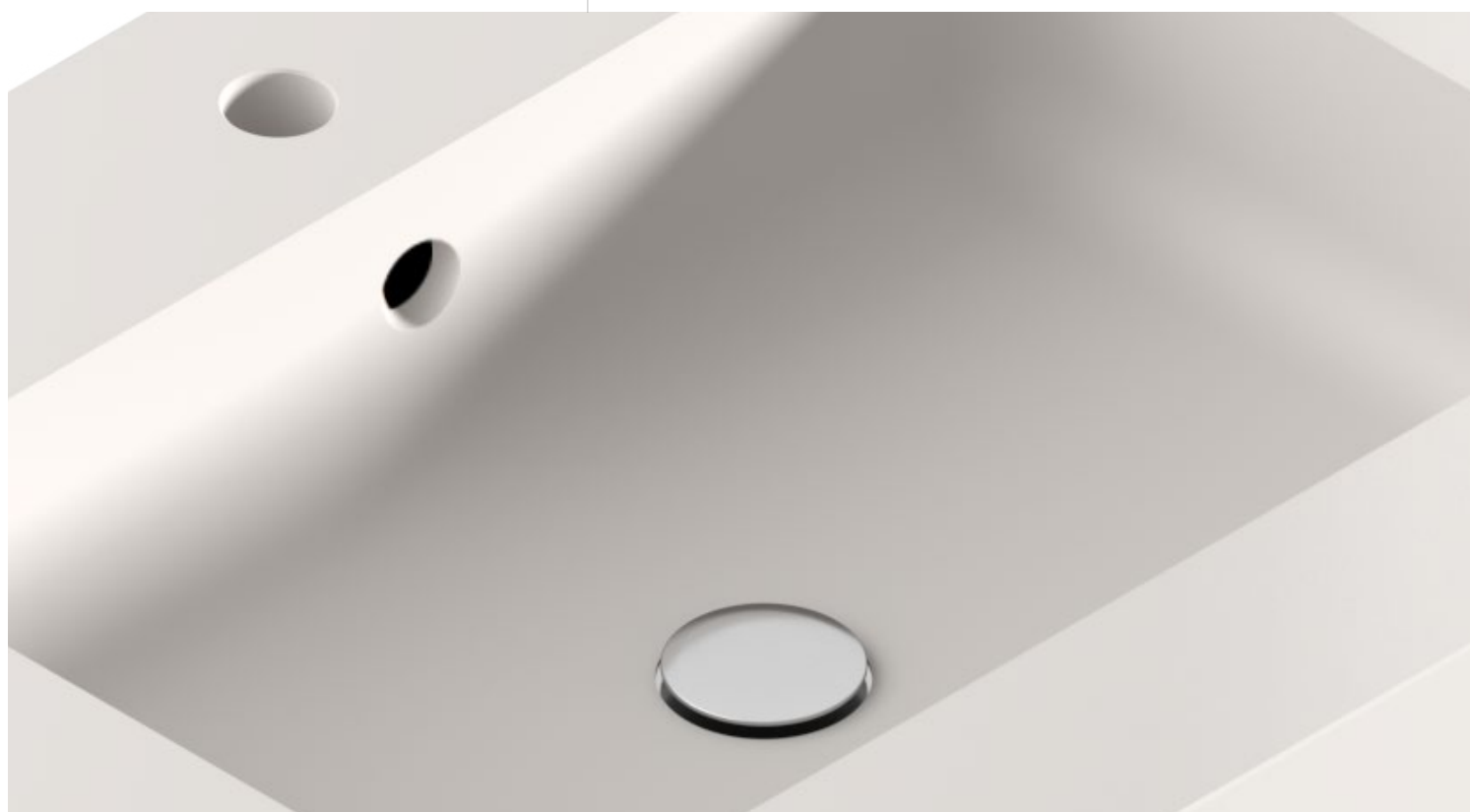

Cosentino Warranty



Washbasins

Shower trays

Bathroom countertops

Cosentino standard warranty letter

This Letter of Warranty (hereinafter, the ‘Warranty’) shall only be fully valid when the consumer has registered the project within 6 months of the purchase of the product, as indicated in the relevant section, and when the consumer submits the original invoice or purchase receipt (indicating the date of purchase and the name of the dealer of the product). The consumer shall send the defective product to COSENTINO GLOBAL S.L.U. (hereinafter, **COSENTINO**). In order to be effective, this Warranty must be registered online on the website www.cosentino.com. This Warranty is transferable

COSENTINO reserves the right not to offer the warranty service free of charge if the requirements set out in the previous paragraph are not met, or if the information provided by the consumer is false, incomplete or illegible.

This Warranty is intended for non-professional end users and shall be considered applicable for residential use, such as any building or facility for private accommodation, whether it is a single-family or multi-family dwelling.

End Products Manufactured by Cosentino

This section of the Warranty is limited to end products manufactured under any of the COSENTINO brands in the form of three-dimensional products, such as kitchen sinks, washbasins, bathroom countertops and shower trays (hereinafter, the ‘**End Products**’), and covers any manufacturing defects in such products for a period of **FIVE (5) YEARS**, from the date of purchase.

All this under the terms, conditions and limitations described for the rest of SILESTONE® or DEKTON® by Cosentino® products in this document and also available on the website.

This Warranty is only valid when the end products have been correctly installed (in accordance with the applicable regulations and the specific assembly instructions), and have been used correctly according to their intended application (Use, Care and Maintenance Guide).

Consumable items (rubber elements, seals, valves, etc.) are not covered under this Warranty.

Warranty Registration:

To register as a holder of this Warranty, it must be activated via www.cosentino.com. This website requires certain information for registration, including information relating to the point of sale and/or the marble supplier, as well as the customer. Therefore, we recommend that customers register directly with the point of sale or marble supplier. At the end of the registration, the customer may print this Warranty for their use.

In order to benefit from the Warranty, it must be registered within six (6) months of purchase.

COSENTINO®

Ctra. Baza a Huércal-Overa, km 59 / 04850
Cantoria - Almería (Spain) / Tel.: +34 950 444 175
info@cosentino.com / www.cosentino.com

